

ES1-275 R 4C 1277 4
RICHARD B FONES JR
25 BALTIMORE-ANNAPOLIS
BLVD-FERNDALE
GLEN BURNIE MD 21061

March, 1975 □ 75 cents

Electronic Servicing



A HOWARD W. SAMS PUBLICATION

**GOODBYE,
COLOR
CONTROLS!**

*Testing unmarked transistors
Modular color repairs*



PTS ELECTRONICS

Precision Tuner Service



now available near you

ALABAMA: PTS ELECTRONICS 524 32ND ST. SOUTH BIRMINGHAM, ALA. 35222 TEL. 205. 323-2647	CALIFORNIA—NORTH: PTS ELECTRONICS 4611 ALBURN BLVD SACRAMENTO, CALIF. 95841 TEL. 916. 482-6220	CALIFORNIA—SOUTH: PTS ELECTRONICS 5111 UNIVERSITY AVE SAN DIEGO, CALIF. 92105 TEL. 714. 280-7070	COLORADO: PTS ELECTRONICS 4958 ALLISON ST ARVADA, COLO. 80001 TEL. 303. 423-7080	FLORIDA—NORTH: PTS ELECTRONICS 12934 N.W. 7TH AVE MIAMI, FLA. 33168 TEL. 305. 685-9811	FLORIDA—SOUTH: PTS ELECTRONICS 1918 BLANDING BLVD. JACKSONVILLE, FLA. 32210 TEL. 904. 389-9952	HOME OFFICE—INDIANA: PTS ELECTRONICS 5233 S. HWY. 37 BLOOMINGTON, IND. 47401 TEL. 812. 824-9331	KANSAS: PTS ELECTRONICS 3115 MERRIAM LANE KANSAS CITY, KANSAS 66100 TEL. 913. 831-1222
TEXAS—EAST: PTS ELECTRONICS 4324-26 TELEPHONE RD. HOUSTON, TEX. 77032 TEL. 713. 644-6793	<p>..new pts products.. ..pts l15 dura-seven..stop..seven piece alignment tool kit..stop..glass- filled polymer plastic for longer life.. ..stop..up to 10 times the life of regular plastic tools..stop ..\$.249.. ..see your distributor or any pts service center..stop.. ..pts elex..not a franchise Co..</p>					LOUISIANA: PTS ELECTRONICS 2914 WYCHWOOD DRIVE METAIRIE, LOUISIANA 70033 TEL. 504. 885-2349	
TEXAS—NORTH: PTS ELECTRONICS MOPAC LANE LONGVIEW, TEX. 75601 TEL. 214. 753-4334						MARYLAND: PTS ELECTRONICS 1105 SPRING ST. SILVER SPRING, MD. 20910 TEL. 301. 565-0025	
TENNESSEE: PTS ELECTRONICS 3614 LAMAR AVE. MEMPHIS, TENN. 38118 TEL. 901. 365-1918						MASSACHUSETTS: PTS ELECTRONICS 191 CHESTNUT ST. SPRINGFIELD, MASS. 01103 TEL. 413. 734-2737	
PENNSYLVANIA—WEST: PTS ELECTRONICS 257 RIVERVIEW AVE. W. PITTSBURGH, PA. 15202 TEL. 412. 761-7648						MICHIGAN: PTS ELECTRONICS 13705 W. EIGHT MILE RD. DETROIT, MICH. 48225 TEL. 313. 862-1783	
PENNSYLVANIA—EAST: PTS ELECTRONICS 1921 S. 70TH ST. PHILADELPHIA, PA. 19142 TEL. 215. 724-0999						MINNESOTA: PTS ELECTRONICS 815 W. LAKE ST. MINNEAPOLIS, MINN. 55408 TEL. 612. 824-2333	
OREGON: PTS ELECTRONICS 5220 N.E. SANDY BLVD. PORTLAND, OREGON 97213 Tel. 503. 282-9636	OKLAHOMA: PTS ELECTRONICS 3007 N. MAY OKLAHOMA CITY, OKLA. 73106 TEL. 405. 947-2013	OHIO—SOUTH: US TUNER SERVICE 8180 VINE ST. CINCINNATI, OHIO 45215. TEL. 513. 821-2298	OHIO: PTS ELECTRONICS 5682 STATE RD. CLEVELAND, OHIO 44134 TEL. 216. 845-4480	NORTH CAROLINA: PTS ELECTRONICS 724 SIEGLE AVE. CHARLOTTE, N.C. 28205 TEL. 704. 332-8007	NEW YORK CITY— NEW JERSEY: PTS ELECTRONICS 158 MARKET ST. E. PATERSON, N.J. 07407 TEL. 201. 791-6380	NEW YORK: PTS ELECTRONICS 993 SYCAMORE ST. BUFFALO, N.Y. 14212 TEL. 716. 891-4955	MISSOURI: PTS ELECTRONICS 8456 PAGE BLVD. ST. LOUIS, MO. 63130

LET US TAKE CARE OF YOUR TUNER PROBLEMS...

PTS will repair any tuner - no matter how old or new - black & white or color - transistor or tubes - varactor or electronically tuned - detent UHF. 8 hour service is a must!

...THIS IS THE SERVICE WE OFFER:

1. Fastest Service—8 hour—in and out the same day. Overnight transit to one of our strategically located plants.
2. Best Quality—Your customers are satisfied and you are not bothered with returning tuners for rework.
3. PTS uses only ORIGINAL PARTS! No homemade or make-do, inferior merchandise (this is why we charge for major parts!). You get your tuner back in ORIGINAL EQUIPMENT condition.
4. PTS is recommended by more TV Manufacturers than any other tuner company.
5. PTS is overhauling more tuners than all other tuner services combined.



Fast **8** hr. Service!

We offer you finer, faster...

...Precision
Tuner Service

1 YEAR GUARANTEE



ELECTRONICS, INC....

...Number ONE and still trying harder!
(Not a Franchise Company)

VHF, UHF \$10.95
UV-COMBO 17.95
IF-SUBCHASSIS 12.50
Major parts and shipping
charged at cost.
(Dealer net!)

Over 4000 exact tuner replacements available for \$14.95 up (new or rebuilt).

For More Details Circle (1) on Reply Card

Your sure-fire smoke detector is here...the Mallory SDA3 Alarm.

Automatically, 'round the clock, when hazardous smoke fumes threaten, it sounds a life-saving intermittent blast—so loud it can break through the deepest sleep.

The Mallory Smoke Detector Alarm is completely self-contained, battery-powered. It installs easily on ceilings—in hallways, bedrooms, wherever warning for escape from lethal combustion products (visible or invisible) is needed.

And the 12.6-volt Mallory battery is specially designed for added security. It changes characteristics after a life of approximately one year and the Alarm then emits a burst of sound at one-minute intervals, signaling that a fresh battery is needed.

All for a price so affordable, every home, apartment, trailer, office can have sure-fire smoke-alarm protection.

For details, see your Mallory distributor.



The SDA3 Alarm is compact, unobtrusive—only 6" x 1 1/16".

MALLORY

MALLORY DISTRIBUTOR PRODUCTS COMPANY

a division of P. R. MALLORY & CO. INC.

Box 1284, Indianapolis, Indiana 46208; Telephone: 317-856-5731

Batteries • Capacitors • Controls • Security Products • DURATAPE® • Resistors • Semiconductors • SONALERT® • Switches • Timing Devices and Motors
DURACELL®, DURATAPE® and SONALERT® are registered trademarks of P. R. Mallory & Co. Inc.

electronicscanner

news of the industry

Jules Steinberg, executive vice-president of NARDA, says the appliance-television dealer must resurvey his market, and keep abreast of customer attitude to be successful in 1975. Steinberg believes the consumer will be more interested in promotional models, making it increasingly difficult for retailers to obtain a reasonable profit. According to Steinberg (as reported in *Home Furnishings Daily*), the most serious problem facing the appliance/electronic sales dealer is a shortage of working capital.

An investigation by the Federal Trade Commission has shown "parts fraud" in 50% of all test repairs in both Washington D.C. and New Orleans, and in 20% of all those in San Francisco. Parts fraud is defined as the unnecessary replacing of parts, or charging for parts that are not actually replaced, states an article in *Home Furnishings Daily*. Also, prices varied widely, with the average price about 20% higher in New Orleans. The TV receivers used during the investigation were new and in "perfect" working order except each had one dead tube. A study based on these repairs said that local laws designed to reduce the incidence of fraud should not allow the repair industry to regulate itself, and that a testing laboratory with staff should be a part of any regulating scheme.

Quasar Electronics is expected to be in the audio business by the end of 1975, according to a report in *Home Furnishings Daily*. The new line of audio products will be shown at the company's June convention.

While the debate continues over the choice of the German PAL or the French SECAM color TV system, a temporary solution has been proposed to reactivate the TV industry in Italy, according to *Onda Quadra* magazine. Dr. Guillermo Gonzales Camarena of Mexico City developed the system, which requires a common b/w TV receiver, color CRT, and a small amount of circuitry. Transmission with the new system (called Simplified Bicolor System, or SBS) is supposedly compatible with current TV broadcasting. Which system to choose has become a political problem, reportedly causing unemployment and dissatisfaction with the ruling party.

Morris L. Finneburgh, Sr., chairman of the board for the Finney Company, has supplied NESDA with 20,000 "tent" cards. The cards can be imprinted with the dealer's name, and left on top of TV sets after service is performed.

David Casbon of Casbon Electric in Valparaiso, Indiana, jokingly advertised on a radio station that he would give away a Pioneer stereo system to anyone who came into his store with an elephant. Bill Wellman stopped by to collect his prize, after borrowing an elephant from a parade to provide a ride home for a political candidate who had dined at Wellman's new restaurant, as amusingly reported in *Home Furnishings Daily*.

(Continued on page 6)

TUNER SERVICE CORPORATION

SUBSTITUNER



INTRODUCING
AT JUST

\$39.95

U.S.A.
ONLY

WITH CABLES

ONE YEAR
GUARANTEE

STILL ONLY

\$9.95

U.S.A.
ONLY

ALL PARTS
INCLUDED

EXCEPT TUBES
AND TRANSISTORS



PROVIDES YOU WITH A COMPLETE SERVICE
FOR ALL YOUR TELEVISION TUNER REQUIREMENTS.

FEATURES

- A UHF Tuner with 70 channels which are detented and indicated just like VHF channels.
- A VHF Hi Gain Solid State Tuner.
- AC Powered
- 90 Day Warranty

Demonstrate the **SUBSTITUNER** to your customers and show improved reception with their TV sets.

You may place your order through any of the Centers listed below.

REPAIR

- VHF OR UHF ANY TYPE (U.S.A. ONLY) \$ 9.95
 UHF/VHF COMBINATION (U.S.A. ONLY) \$15.00
- IN THIS PRICE ALL PARTS ARE INCLUDED. Tubes, transistors, diodes, and nuvistors are charged extra. This price does not include mutilated tuners.
 - Fast, efficient service at our conveniently located Service Centers.
 - All tuners are ultrasonically cleaned, repaired, realigned, and air tested.

REPLACE

- UNIVERSAL REPLACEMENT TUNER \$12.95 (U.S.A. only)
- This price buys you a complete new tuner built specifically by Sarkes Tarzian Inc. for this purpose.
 - All shafts have a maximum length of 10½" which can be cut to 1½".
 - Specify heater type parallel and series 450 mA. or 600 mA.

CUSTOMIZE

- Customized tuners are available at a cost of only \$15.95. With trade-in \$13.95. (U.S.A. only)
- Send in your original tuner for comparison purposes to Franchises listed below.



HEADQUARTERS	BLOOMINGTON, INDIANA 47401	537 South Walnut Street	Tel. 812-334-0411
ARIZONA	TUCSON, ARIZONA 85713	P.O. Box 4534, 1528 S. 6th Ave.	Tel. 602-791-9243
CALIFORNIA	NORTH HOLLYWOOD, CALIF. 91601	10654 Magnolia Boulevard	Tel. 213-769-2720
	BURLINGAME, CALIF. 94010	1324 Marsten Road	Tel. 415-347-5728
	MODESTO, CALIF. 95351	123 Phoenix Avenue	Tel. 209-521-8051
FLORIDA	TAMPA, FLORIDA 33606	1505 Cypress Street	Tel. 813-253-0324
	HIALEAH, FLORIDA 33013	906 East 25th Street	Tel. 305-836-7078
GEORGIA	ATLANTA, GEORGIA 30310	938 Gordon Street S.W.	Tel. 404-758-2232
ILLINOIS	CHAMPAIGN, ILLINOIS 61820	405 East University Street	Tel. 217-356-6400
	CHICAGO, ILLINOIS 60621	737 West 55th Street	Tel. 312-873-5556-7
	SKOKIE, ILLINOIS 60076	5110 West Brown Street	Tel. 312-675-0230
INDIANA	HAMMOND, INDIANA 46323	6833 Grand Avenue	Tel. 219-845-2676
	INDIANAPOLIS, INDIANA 46204	112 West St. Clair Street	Tel. 317-632-3493
KENTUCKY	LOUISVILLE, KENTUCKY 40208	2920 Taylor Boulevard	Tel. 502-634-3334
LOUISIANA	SHREVEPORT, LOUISIANA 71104	3025 Highland Avenue	Tel. 318-221-3027
MARYLAND	BALTIMORE, MARYLAND 21215	5505 Reisterstown Rd., Box 2624	Tel. 410-358-1186
MISSOURI	ST. LOUIS, MISSOURI 63132	10530 Page Avenue	Tel. 314-429-0633
NEVADA	LAS VEGAS, NEVADA 89102	1412 Western Avenue No. 1	Tel. 702-384-4235
NEW JERSEY	TRENTON, NEW JERSEY 08638	901 North Olden Avenue	Tel. 609-393-0999
	JERSEY CITY, NEW JERSEY 07307	547-49 Tonnetle Ave., Hwy. 1 & 9	Tel. 201-792-3730
OHIO	CINCINNATI, OHIO 45216	7450 Vine Street	Tel. 513-821-5080
	CLEVELAND, OHIO 44109	4525 Pearl Road	Tel. 216-741-2314
OREGON	PORTLAND, OREGON 97210	1732 N.W. 25th Avenue	Tel. 503-222-9059
TENNESSEE	GREENEVILLE, TENNESSEE 37743	1215 Snapps Ferry Road	Tel. 615-639-8451
	MEMPHIS, TENNESSEE 38111	3158 Barron Avenue	Tel. 901-458-2355
TEXAS	DALLAS, TEXAS 75218	11540 Garland Road	Tel. 214-327-8413
VIRGINIA	NORFOLK, VIRGINIA 23513	3295 Santos Street	Tel. 804-855-2518
WISCONSIN	MILWAUKEE, WISCONSIN 53216	4722 W. Fond du Lac	Tel. 414-871-7655
CANADA	ST. LAURENT, QUEBEC H4N-2L7	305 Decarie Boulevard	Tel. 514-748-8803
	CALGARY, ALBERTA T2H-0L1	448 42nd Avenue S.E.	Tel. 403-243-0971
		P.O. Box 5823, Stn. "A"	

WATCH US
GROW

March, 1975

IF YOU WANT TO BRANCH OUT INTO THE TV TUNER REPAIR BUSINESS,
WRITE TO THE BLOOMINGTON HEADQUARTERS ABOUT A FRANCHISE.

For More Details Circle (6) on Reply Card

(Continued from page 4)

Chemtronics Incorporated has moved from Brooklyn, New York to larger quarters on Long Island. According to Al Friedman, president of Chemtronics, the move was made to improve operation efficiency and accommodate the company's growth.

Matsushita Electric Corporation of America has retained a research firm to conduct a separate study concerning more than 400,000 color TV sets said by the FDA to be potentially hazardous. Matsushita claims the sets are safe, but has submitted a corrective-action plan as ordered to do by the FDA. **Home Furnishings Daily** reports a Matsushita representative said the company feels the component failure occurred under abnormal laboratory conditions and should not occur in normal home use. It was reported the component failure could result in unsafe radiation emissions, involving only solid-state color sets with screen sizes from 9-inches to 25-inches. Pending notification of correction of the sets, an FDA official said viewers would be safe when sitting at least 6 feet away from the set.

Montgomery Ward has followed the example set by Sears, Roebuck and Company, and established a one-year parts and labor warranty on all solid-state color TV sets offered in its 1975 spring-summer catalog. Sears has had the one-year warranty since its 1974 fall-winter catalog, but is changing to a 90-day warranty because of the recent trend in the TV industry, according to **Home Furnishings Daily**.

RCA has clarified its plans to reduce service warranties on 1976 solid-state color and monochrome TV lines. The present one year parts warranty will not be changed on color TV, but will be reduced to 90 days for solid-state monochrome sets, according to **Home Furnishings Daily**. Existing kinescope warranties reportedly will not be changed.

The virus of leukemia has been isolated and photographed by a team of two researchers from the "Istituto di Patologia Generale dell'Universita' di Roma", according to the Italian magazine **Onda Quadra**. Professors M. Torrioli and G. Torrioli Riggio used a Philips EM 300 electronic microscope.

Zenith Electronics will purchase from Philco-Ford an 850,000-square-foot plant in Watsonstown, Pennsylvania which will be used to consolidate all modular and console stereo production under one roof. An expanded manufacturing of TV components and sub-assemblies is expected when the transition is complete, reports **Home Furnishings Daily**. Philco-Ford reports they are in the process of reducing their national sales force, and plan to establish a new organization of regional managers. □

Earn an extra \$2000 per year

Find out how you can earn an extra \$2000 or more per year restoring only a few color and black and white tubes per week. Full color brochure shows you how to make more money and satisfy more customers on almost every call. **Write today!**



New



467 CRT
Restorer/Analyzer
\$279*

With the profit restorer!

Profit in the home. After replacing a component you've often noticed a less than perfect picture. It's almost always due to a weak picture tube. The few minutes you spend with the 467 Restorer will give your customer brilliance and sharpness that will make her pleased to pay for the improved picture.

Profit in the shop. "Sixty-five dollars and the picture still doesn't look as good as it used to!" How many times have your customers said that to you? You need not hear it again! Use the 467 Restorer on every major job and your customer will thank you for returning his set working like new.

Most-Powerful Rejuvenation, but most gentle too. There's only one CRT Restorer that restores the picture to like new and analyzes tube condition so accurately that you can safely guarantee restoration for up to five years. You get extra safety from our automatic restoration method that prevents cathode stripping.

TriDynamic true test. The B & K TriDynamic method tests all three guns simultaneously. It measures true beam current that passes through G1 aperture, unlike other testers that measure meaningless cathode to G1 current. Leakage indication even includes cathode-to-cathode and there's an exclusive B & K focus continuity test.

Simplest operation. Exclusive integrated circuitry lets you test all picture tubes with the same, defined-on-the-front-panel procedure . . . including "in-line", Trinitron and tubes with common G1 and G2. See your distributor or write Dynascan.

*Six sockets included;
optional sockets also shown.

B&K PRODUCTS OF
DYNASCAN
1801 W. Belle Plaine Ave.
Chicago, IL 60613 • (312) 327-7270

Chassis—RCA CTC63
PHOTOFACT—1362-2

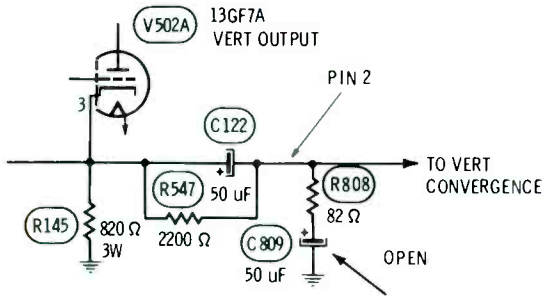

Symptom—Insufficient height, and poor convergence
Cure—Check C809 (on convergence board), and replace it if open

Chassis—RCA CTC58
PHOTOFACT—1365-1

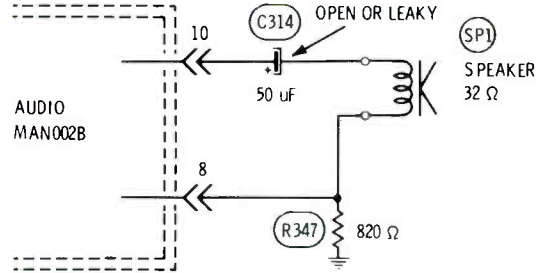

Symptom—Distorted, weak, or no volume of sound
Cure—Check C314, and replace it if open or leaky

Chassis—RCA CTC68
PHOTOFACT—1378-2

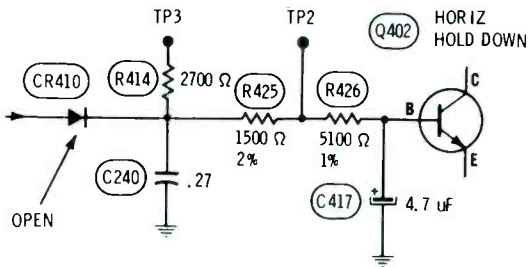

Symptom—Inoperative horizontal hold-down circuit
Cure—Check CR410, and replace it if open

Chassis—RCA CTC46 (all XL-100)
PHOTOFACT—1243-2

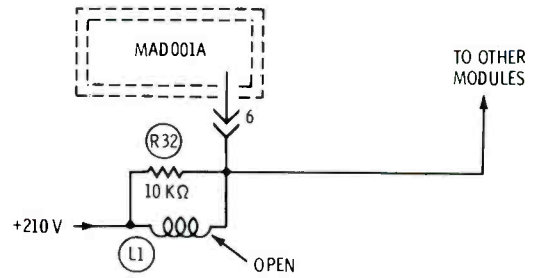

Symptom—Excessive video smear in picture
Cure—Check peaking coil L1, and replace it if open

Chassis—RCA CTC58
PHOTOFACT—1365-1

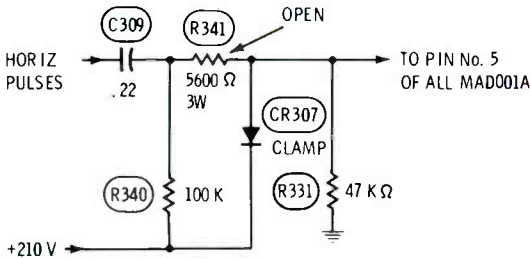

Symptom—Low brightness (brightness increases if HV is decreased)
Cure—Check R341, and replace it if open

Chassis—RCA CTC62
PHOTOFACT—1345-2

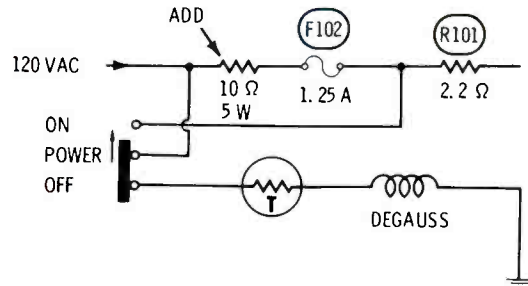

Symptom—Slow warmup of picture
Cure—Check F102, and replace it if open. Either add a resistor as shown, or increase the fuse to 1.5A slow-blow

Service back-up

Quasar's back-up programs are designed to help our thousands of authorized servicers keep their customers happy.

We design Quasar TV serviceability with you in mind. Our own service experts are, in fact, involved in design at the drawing board stage. Their contributions help you perform your job more professionally to help enhance your image with consumers. Such keen awareness of your needs helped lead to our pioneering in modular chassis concepts.

Our regular, practical training helps keep you up to date. Quasar's 83 distributors conduct thorough training seminars regularly to acquaint servicers with newly-introduced products and to pass along updated servicing techniques. Quasar even provides practical, valuable service literature regularly for a nominal subscription fee.

Our speedy PACE parts availability system helps you maintain customer good will. To help you satisfy most consumer problems promptly, yet help keep your shop inventory reasonable, Quasar offers its PACE program through distributors. Using this optional program, the distributor can stock 90% of all parts you'll ever need. Beyond that, we'll drop-ship through our distributors from the factory direct to you.



A new company with new solutions for today.

Quasar Electronics Corporation
A subsidiary of Matsushita Electric Corporation of America

troubleshootingtips

Send in your helpful tips—we pay!

No color General Electric H-1 color chassis (Photofact 883-3)

The b-w picture was normal, and the fine tuning could bring in sound bars. This indicated the loss of color was in the chroma circuit.

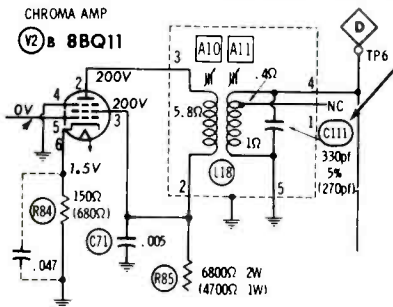

Scope waveforms showed strong color at the grid of V2B, the chroma-amp tube, and sufficient

amplitude at the plate. However, the amplitude at the cathode of V5B (burst gate) was weak and noisy.

Signal for the cathode comes from the secondary of L18, and it measured very weak at testpoint 6 (D).

There was too much loss between primary and secondary of L18, and the windings tested okay for resistance. From those facts, I suspected C111 might be open, and the installation of a new one brought back the color. Because C111 tunes the secondary, replacement sometimes makes realignment necessary. In this case, the color quality was good, so adjustment was not required.

Serge Thibodeau
Quebec, Canada

Power Won't Turn Off Panasonic AN-409TA b-w TV (Photofact 1077-1)

Neither the on/off switch nor the timer would remove power from the receiver. Pulling the AC plug was the only way the set could be turned off.

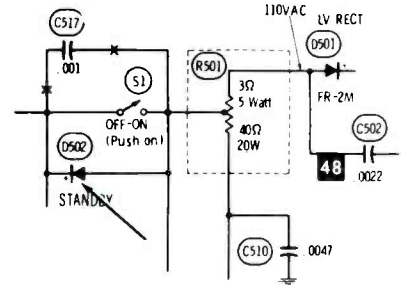

I tested the on/off switch and timer for stuck contacts, and then found D502 was shorted. It was in parallel with the switch, making the switch ineffective. A new diode restored normal operation.

Charlie Jackson
Buckner, Illinois

Burned resistor, no HV RCA CTC49XA color chassis (Photofact 1187-2)

This solid-state receiver had no high voltage when brought to the

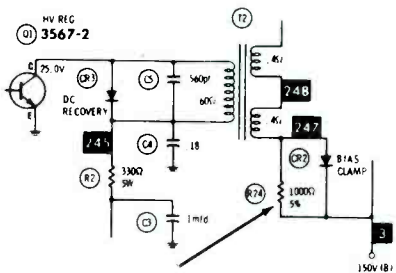

shop. After it was turned on, R24 started smoking immediately. I removed the resistor and checked resistance from each end to ground. Both readings were up in the megohms, thus indicating no per-

manent short.

A new resistor was installed, and a short application of power produced too much heat. By touching the test prod, then turning on the power for a second or so, I measured +160 volts on one end of R24 and only about 8 volts on the other. No wonder the resistor was burning!

During some careful ohmmeter tests (with power off) I found an open at the primary of transformer T3. A quick soldering job fixed the problem.

When the open at T3, the entire current for the SCR's was flowing through R24, and not just the amount needed for HV regulation.

Ronn Ross, CET
Milwaukee, Wisconsin

Intermittent color locking Sears Silvertone 562.10220 color chassis (Photofact 916-3)

When stations were selected, or fine tuning adjusted, the color would lose color locking ("barber-pole").

I grounded testpoint "L" and adjusted the reactance coil for zero beat. This seemed to improve the locking. But later a channel change again forced it out of lock. Grounding of the testpoint showed the frequency had not drifted, and indicated the trouble might be in the phase-detector circuit.

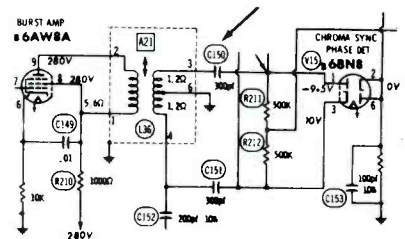

While testing the components of the phase detector, I found C150 to be sensitive to heat and cold. A new capacitor stopped the loss of color locking.

Hall's TV Service
Hartwell, Georgia

No sound from tape head Panasonic RQ309 and RQ409 tape recorder

Several of these tape recorders have been found with the leads broken at the head.

Remove the unit from the case, and inspect the play/record head. In some machines, the red and white wires were cut too short. The strain on the leads when the

machine is playing can break one or both wires.

Either completely replace the broken wire; or splice on about a half-inch of #22 stranded, insulated wire, and cover the splice with spaghetti. Solder the wire to the head, and check for sufficient slack of the leads.

Pierce D. Crank
Goldsboro, North Carolina

**Intermittent color
Philco 19FT60B color chassis
(Photofact 1133-2)**

After about 15 minutes of normal operation, the color would disappear, leaving a normal b-w picture. Tapping around the color oscillator occasionally would restore the color.

In previous cases, I have had problems with the 3.58-MHz crystal, so I replaced it on suspicion.

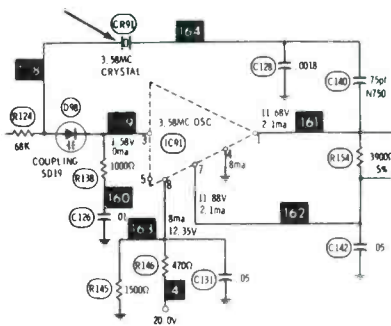

That stopped the loss of color.
Joseph Rotello, Jr.
Tucson, Arizona

**Intermittent height
RCA CTC25 color chassis
(Photofact 879-3)**

The height was stretched and could not be locked because the frequency was wrong. I replaced the feedback capacitors, and that seemed to cure the problems.

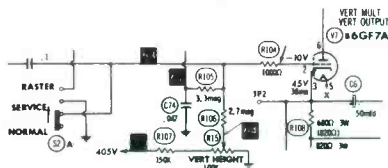

Two months later, the customer complained of the same symptoms. This time I replaced the remaining components which are likely to cause the troubles. But there was no cure.

After some testing, I noticed that slightly moving the service switch would cause the height to change. I cut loose the wire from the grid of the output tube to the switch, and this restored proper operation. Evidently the switch had leakage to ground (even several megohms is enough) that was disturbed temporarily by the previous repairs. I installed a new switch, because cleaning is not permanent.

Ken Rector
Long, Beach, California
Editor's Note: Leakage of the

service switch has been found to be the cause of insufficient height and wrong vertical frequency in many different models, including those with switches in series with the coupling capacitor. Ohmmeter tests often are not conclusive; disconnect the switch as a test.

**Intermittent HV and raster
General Electric H-4
color receiver
(Photofact 1223-2)**

All the horizontal-sweep tubes were tested and found to be okay. The drive voltage at the grid of the 12JF5 was normal, even when the raster disappeared. From those tests, I knew the intermittent was in the sweep circuit beyond the plate of the output tube.

By making tests during the times the raster disappeared, I found the high voltage was intermittent. Also, when the HV was gone, the output

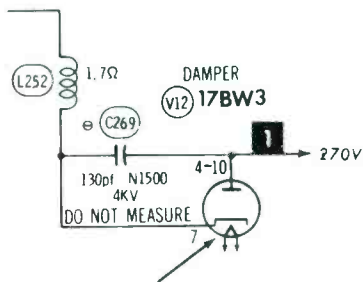

tube screen-grid voltage was low and the control-grid voltage was more negative. This indicated the plate was not receiving B+, and the screen-grid was drawing more current. It seemed logical that the output tube socket was bad, but the problem remained after I installed a new one.

Reasoning that the supply voltage for the output tube came from the damper, I replaced it, and the problem was solved. As extra insurance, I moved the capacitor and RF choke (which had been mounted to the top of the damper socket) to the bottom and soldered them direct to the socket pins.

Matt Rusk
St. Petersburg, Florida □

For news of
our industry,
read Electronic Scanner,
page 4

FAST

COMPLETE SERVICE ON ALL MAKES OF TV TUNERS

Maximum Time In Shop 24 Hrs.

(WE SHIP C.O.D.)
YOU PAY SHIPPING
\$9.95

(Warranty: One Full Year)

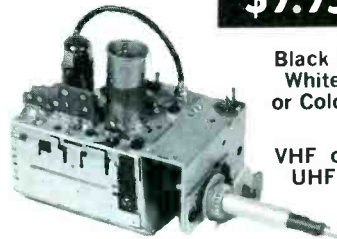

Black &
White
or Color

VHF or
UHF

UV Combo's \$16.50

Price includes all labor and parts except Tubes, Diodes & Transistors. If combo tuner needs only one unit repaired, disassemble and ship only defective unit. Otherwise there will be a charge for a combo tuner. When sending tuners for repair, remove mounting brackets, knobs, indicator dials, remote fine tuning arrangements and remote control drive units.

WE UNCONDITIONALLY GUARANTEE All Tuners FOR ONE FULL YEAR



All tuners are serviced by EXPERTLY TRAINED TECHNICIANS with years of experience in this specialized field. All tuners are ALIGNED TO MANUFACTURER'S SPECIFICATION on crystal controlled equipment and air checked on monitor before shipping to assure that tuner is operating properly.

GEM CITY TUNER SERVICE

Box 6G Dabel Station
1621 Mardon Drive
Dayton, Ohio 45420

A Servicer's Day in France

By David A. Ferre'



Compare your business and technical operations with those of the "House Of Radio" in Pamiers, France. Perhaps you'll get some ideas, and surely you will recognize some similarities.

During a recent visit to the southern village of Pamiers, France (population 20,000), I met Jean Papaix, owner of the "House Of Radio", which was founded by his father. I spent a day with Jean to see how he conducted his business. It was a fascinating glimpse into another world, and yet much was familiar.

The work load for the day was not very heavy, only three service calls and one color setup.

Before leaving the shop, Jean put on a white smock, similar to the kind some doctors wear. This gave a professional appearance, and was less expensive than a tailored uniform.

Radio/Hi-Fi

At the first service call, we found an old (but well-polished) six-foot Telefunken radio/Hi-Fi. The complaint was "distorted sound". After some tests, we found the cone of the 10-inch speaker was dragging against the polepiece.

The customer was quoted a total price of \$35, and was told that a new speaker should arrive in about a week. He approved the repair.

Parts for all popular brands of electronic equipment are available from Paris. Delivery usually is fast,



At the *House Of Radio* in Pamiers, France, attractive window displays draw customers into the store for a closer look. The store is kept spotlessly clean, and even the sidewalk is swept. Selling prices are comparable to those in the United States.



Displays of new television receivers are located among smaller appliances, to interest customers in the many types of goods for sale. Prices of large-screen color TV's range from \$700 to \$1,000. Warranty is one year for both parts and labor. Trade-in b-w sets are reconditioned and sold for \$100 to \$175.

with delays only for the "off-brands". Service data is available only direct from each manufacturer (Photofact take notice).

Black And White TV

The complaint at the second call was poor vertical linearity and erratic locking on a b-w TV receiver. Only a new vertical tube and adjustments of height and linearity were required for this simple repair.

Charges were: service call \$7.00, and tube \$6.10. But to the reasonable total of \$13.10 was added the French VAT (value-added tax) of 23%, bringing the final bill up to \$16.11.

Two Repairs

The last repair and the color TV setup were both at the same place, a cafe in Mirepoix, about 15 miles away from Pamiers.

As he drove to Mirepoix, Jean explained how his father had started the business by selling radios and small appliances just after World War II. Now the business had expanded into full sales and service of electronic goods, plus small appliances (shavers, light fixtures, clocks,

vacuum cleaners, irons, phonograph records, fans, toasters, and blenders); plus electric and acoustic guitars, and a full-line of gas camping lights.

First, we examined the ailing bar-room TV that had sound but no raster. Tube replacements didn't help, so we carried the TV to the Renault wagon for the trip back to the store, and turned our attention to the new color TV located in the living quarters at the rear of the cafe.

The color set was working okay, but didn't have an antenna, so the picture was snowy and not too sharp. Few, if any, indoor antennas are used, so "rabbit ears" for temporary operation were not available.

Jean called his store and left a message for this part-time helper, Andre, to come to the cafe and run new antenna wires.

After that, we left Mirepoix and, with the TV from the cafe, started back to Pamiers.

90 Minutes For Lunch

We arrived at the store just as the secretary was closing the door for the usual one-and-a-half hour lunch break. After a leisurely lunch

(that was anything but a sobering experience!), we turned our attention to the bar-room TV we had brought back.

No Raster, No Sound

After allowing enough time for the TV to warm up, we found there was no sound, in addition to the original problem of no raster.

Because the lack of sound was a new defect, we checked the sound circuit first, but found nothing wrong.

After our attention was directed to the no-raster symptom, we didn't take long to find an open fuseable resistor in the horizontal-output circuit. The resistor didn't seem to be overheated very badly, so it was replaced, along with the horizontal-output tube "just in case".

Now, there was a raster, but no sound or picture. The defect was found to be a loose plug between the tuner and the chassis. Possibly it was jarred loose by the hauling. Jean called the cafe and told the proprietor when to expect delivery of the repaired set.

Just then, Andre arrived and received the message about installing the new antenna lead-in. Also, he was instructed to return the repaired set with a total bill of



The secretary/saleslady answers the telephone, schedules service, and makes sales.

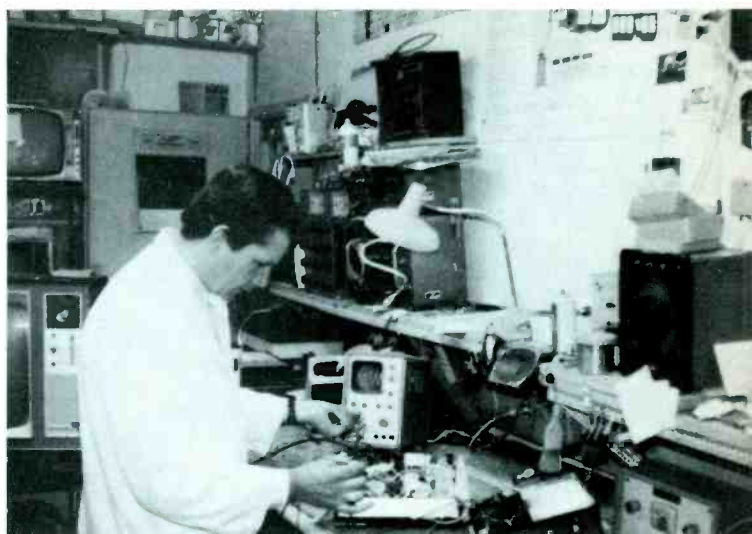

Jean Papaix is shown working on a small tape recorder. His modern test equipment includes a wide-band scope, FET multimeter, RF signal generators, tube testers, color generator, and many more.

MAISON DE LA RADIO

ETS PAPAIX & FILS
—★★—

Chaines Haute Fidélité PHILIPS et DUAL
ELECTROPHONES, MAGNETOPHONES, TRANSISTORS

Grand Choix de Disques
TELEVISION
Couleur — Noir et Blanc

PHILIPS-OCEANIC

SONORISATION

Electro-Ménager
Service après Vente
Grand Choix de Lustrerie

—★★—

PAMIERS — 45, rue Gabriel-Péri — Tél 550
MAZERES — 5 & 7, rue Gaston de Foix — Tél. 25
Horlogerie - Bijouterie - Grand Choix pour Cadeaux

Can you read this business card? On the original card, some words were printed in color, for emphasis.

\$28.30. The antenna connection was to be made at no-charge, because the cafe owner was in an excellent position to recommend Jean's business to his cafe customers.

Business Information

The days work was finished at about 4:00 PM, and we proceeded to a local cafe where we talked as we ate.

Most of the TV receivers Jean

repairs are tube types, with a few hybrids (tube/transistor). The straight-forward circuits with plenty of tubes reminded me of the "good old days".

Jean pays his secretary/saleslady \$75 per week; and Andre, the part-time helper, receives \$1.50 per hour. Jean, the owner, clears about \$150 per week.

The store is open from 9:00 AM to 7:00 PM, with closing for lunch

from noon until 1:30 PM, and is closed on Sundays and Mondays. Rent on the building is only \$85 per month, and Jean has had his store in this location for seven years.

It was pleasant to notice that the customers genuinely liked the TV/appliance man. Jean Papaix is a highly-respected man in the community, and is considered to be hard working, honest, and skilled. □



Fast-moving tubes and transistors are kept in stock. Most other parts come from Paris, with delivery requiring 3 to 5 days.

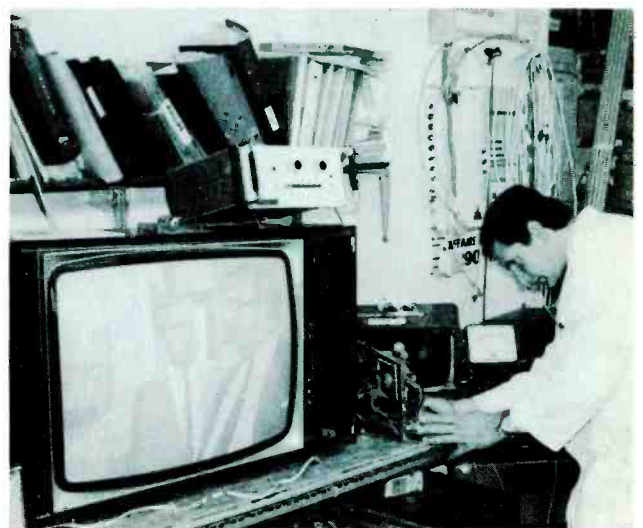

A small b-w portable is shown being checked by Jean. At the left is the color set from the cafe, cooking for a time before delivery. The total bill for parts, labor, transportation and tax was only \$28.30.

GOODBYE COLOR CONTROLS!

By Carl Babcoke

Can you imagine color-TV receivers without any manual controls or automatic circuits to determine color saturation or tint? Well, this is one eventual goal of the Vertical Interval Reference (VIR) signal soon to be added to the transmitted signals from broadcasting stations.

In the future, color-television receivers probably will have only a volume control and a channel selector—no color adjustments or sweep-locking controls!

Even now, the trend is away from vertical and horizontal locking controls. A few models have digital circuits providing the vertical-sweep frequency by counting down from double the horizontal frequency. Some sets have horizontal locking so stable that the controls can be in out-of-the-way locations. Therefore, it's safe to say that **both** vertical and horizontal locking controls **could** be eliminated, if the manufacturers so desired.

On the other hand, color saturation and tint controls are always included. It has been said that such controls must be there to give the viewers a choice of the kind of color. I doubt if this is the main reason.

There are no viewer choices at all in the movie houses. If the sky is slightly purple and the foliage more blue than green, few patrons even notice or complain. But it's likely they would grumble if every change of scene showed a different brightness and color tint. A constant shifting of color quality is very disturbing; whereas, the eyes adjust to unvarying conditions, and they soon are accepted as normal. Therefore, eliminate the shifts from

green faces in a commercial to excessive saturation a few seconds later during a program, and most of the need for controls will be gone.

Almost all changes of TV color quality originate at the broadcasting stations or their program sources, not in the receivers or antennas.

Variations Of Broadcast Color

The reasons for noticeable variations of color quality during TV broadcasts are too numerous to list, coming as they do from problems with color films, video-tape recorders, and accumulated electronic tolerances. It is sufficient to say the broadcast industry is aware of all these deficiencies, and is making strenuous efforts to correct them.

Standardization of color quality should (and will) be done before it is broadcast, not afterwards. Modern receivers have too much circuitry whose only function is to minimize broadcast variations of color. If all TV shows were broadcast with exactly the same color and tint, a receiver probably would need only factory-trimmed components or adjustments (no customer-operated controls) for color and tint, plus simple ACC circuitry to compensate for any differences of chroma gain because of poor antenna response.

Color-correction in receivers

Because TV programs could not be broadcast with consistent color, the receiver manufacturers have tried many ingenious stop-gap methods of making the variations less noticeable.

The correct phase angle of 90° between R-Y and B-Y has been tried at many values between 105° and 140° , sometimes giving the customer a choice by means of a switch. Also, quite often the raster was made slightly reddish. Such deviations do make hue-control settings less critical by expanding the range of orange tints, but at a loss of color fidelity (deep reds tend toward oranges).

Elaborate Automatic Tint Con-

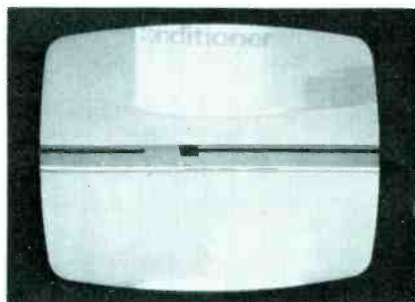

Fig. 1 Roll down the picture using the vertical-hold control to show the VIT signals as white lines and dots below the "hammer". If height is insufficient, the VITS can be seen just above the top of the picture.

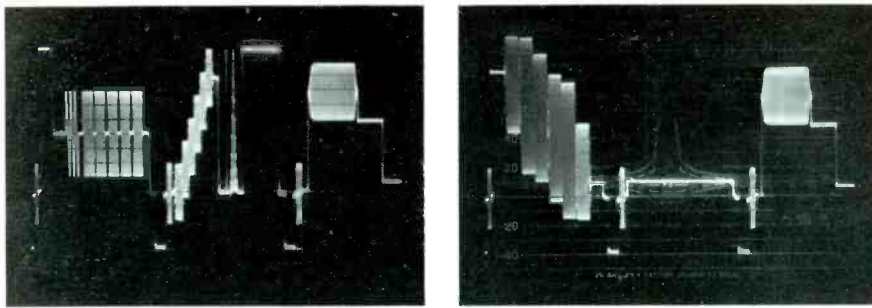

Fig. 2 These waveforms were made direct from a generator and show the VITS and VIRS the way they should look, if network, stations and receivers had infinite bandwidth.

trol (AFT) circuits operate to change the chroma phase of almost-orange colors into an orange that is approximately correct for caucasian skin tone. Hue variations are minimized, but the trade-off is the elimination of any **desired** subtle differences of orange hues.

"Single-button" types of color adjustment merely substitute pre-set conditions for the customer's judgment; these are a convenience, but do not improve the pictures.

Enter VITS and VIR

Tests of network and broadcasting station characteristics made only during maintenance periods are quite accurate and comprehensive, but they are of little help in spotting variable color conditions happening during the normal programming.

For many years, the Federal Communications Commission (FCC) has permitted networks and individual stations to originate Vertical-Interval Test (VIT) signals as a tool to evaluate the characteristics of the video signals. At first, only

the networks used the VITS to keep a constant check on their long lines.

In 1971, The FCC required all TV stations to originate and use VIT signals for remote operation (where studio and transmitter are in different locations). Other stations could use them or not, as they wished.

VIT Signals

Originally, VIT signals were confined to part of line 17 (although I have never seen it used for the purpose), all of lines 18 and 19 of Field #1, and lines 18 and 19 of Field #2. No other video is used in the vertical interval of 21 horizontal-scanning lines, so addition of the VITS has no effect on the picture, or on the vertical and horizontal locking.

You can see the VIT signals in a TV picture by either of two different methods. Roll down the picture, using the vertical-hold control, and look near the bottom of the black blanking bar (Figure 1). The white lines and dots are the

VITS. Or, decrease the height or linearity adjustments, and the VITS become visible at the top of the raster.

Although a technician can look at a scope VITS waveform taken from a video detector and obtain an approximate idea of the bandwidth of the receiver, the VITS is not designed for use in receiver servicing. Instead, the value is in testing the performance of a complete color transmitter, a studio-to-transmitter microwave link (STL), network long lines, a video tape recorder, or any other item of video equipment, but without interfering with the normal operation of the equipment.

Service-type triggered-sweep scopes can display the VITS, but there are problems of video bounce and low brightness (only about 2 lines out of 525 are shown). Broadcast scopes not only supply the VITS waveforms at high brightness and good stability, but also show vector (phase) patterns for precise measurements.

Incidentally, any previously-inserted VITS can be removed and new signals inserted at any point where the equipment is available. For example, a station operating by remote control would be required to erase any network VITS and insert their own for testing the STL. Quite often, Polaroid pictures are made for permanent records.

What VITS test

Figure 2 shows lines 18, 19, and 20 at the output of a VITS generator. The original photographs showed the square corners and excellent sharpness seldom seen after

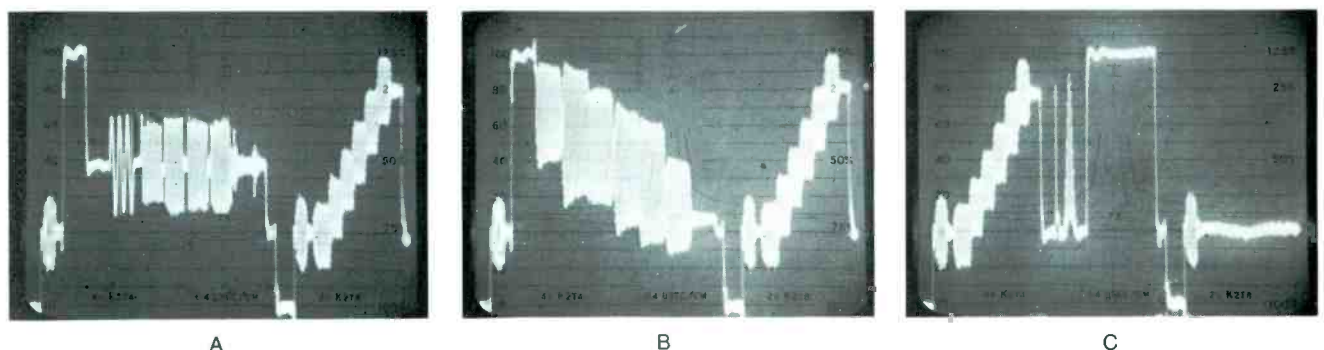
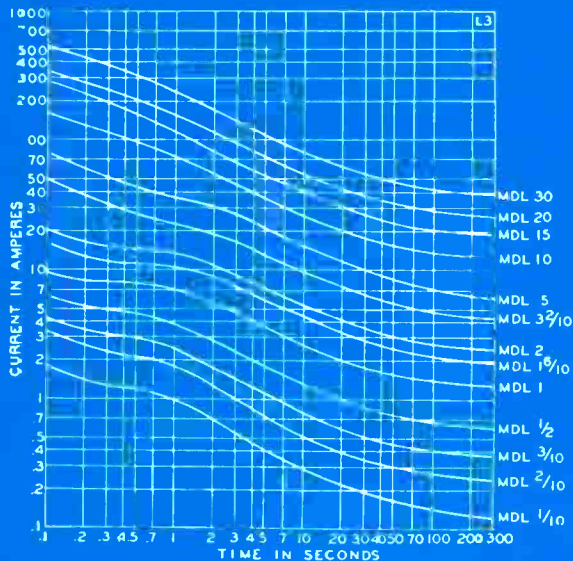

Fig. 3 Compare the waveforms of Figure 2 with these typical ones found at the end of a long microwave network. (A) At the left is the multi-burst display of Field #1, line 18. Response is good, but the amplitude is a bit ragged. Part of line 19 is at the right. (B) Six color bars occupy line 18 of Field #2. (C) Line 19 of both fields have the staircase and the various pulses that are explained in the text. Amplitude at 3.58 MHz is about -1 dB, according to the 12.5T pulse. Some slight overshoot is visible.

NEED A 1/4" x 1-1/4" TIME-DELAY FUSE OR QUICK-ACTING FUSE?

BUSS HAS IT!

Time-current characteristics of FUSETRON® dual-element time-delay fuses



Time-current characteristics of BUSS® fast-acting fuses

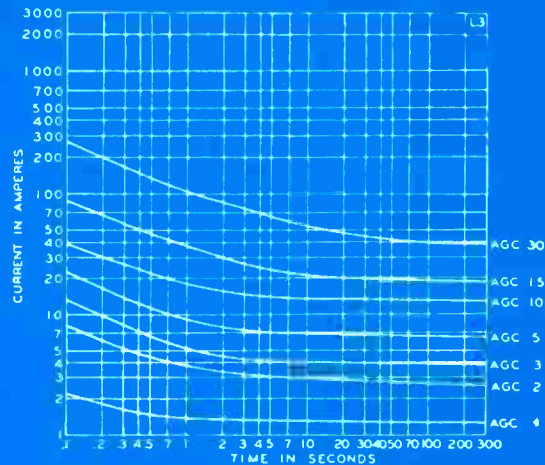

FUSETRON® dual-element fuses

Time-delay characteristics avoid nuisance openings from starting currents or surges—yet, give full protection from short-circuits or dangerous overloads.

Voltage	Symbol	Amperes
250 or less	MDL	1/100, 1/32, 1/16, 1/10, 1/8, 15/100, 175/1000, 3/16, 2/10, 1/4, 3/10, 3/8, 4/10, 1/2, 6/10, 7/10, 3/4, 8/10 or 1
250 or less	MDX	1-1/4, 1-1/2, 1-6/10, 1-8/10 or 2
125 or less	MDL	1-2/10, 1-1/4, 1-1/2, 1-6/10, 2, 2-1/2, or 2-8/10
125 or less	MDX	3, 3-2/10, 4, 5, 6-1/4 or 7
32 or less	MDL	3, 3-2/10, 4, 5, 6-1/4, 8, 10, 15, 20, 25 or 30



BUSS® fast-acting fuses

Fast-acting characteristics provide the instantaneous high speed opening necessary to protect sensitive instruments or delicate apparatus.

Voltage	Symbol	Amperes
250 or less	AGC	1/500, 1/200, 1/100, 1/32, 1/16, 1/10, 1/8, 15/100, 175/1000, 3/16, 2/10, 1/4, 3/10, 3/8, 45/100, 1/2, 6/10, 3/4, 1, 1-1/4, 1-1/2, 1-6/10, 2
250 or less	MGB	1/16 or 1/8 MBW & MBB fuses now called AGC.
250 or less	AGC	2-1/2, 3
250 or less	MTH	4, 5 or 6
125 or less		For 250 volt fuses above 6 amperes—See ABC fuses.
125 or less	GLH	7, 8 or 10
32 or less	AGC	4, 5, 6, 7, 7-1/2, 8, 10, 15, 20, 25 or 30

For a complete selection of BUSS fuses and fuseholders ask for bulletin SFB.



BUSS In-the-Line Fuseholders

HKP Fuseholder

BUSS Panel Mounted Fuseholders Lamp Indicating

BUSS HGB-C Fuseholder Military Type FHL11U

BUSS Space Saver Panel Mounted Fuseholders

BUSS HMR Shielded Panel Mounted Fuseholders

BUSS Snap-Lock Rear Panel Mounted Fuseholders

BUSS Panel Mounted Fuseholder

Fuse Blocks For 1/4 x 1 1/4 Inch Fuses No. 4408 2 pole



BUSSMANN MANUFACTURING
a McGraw-Edison Company Division
St. Louis, Missouri 63107



the signals travel through other equipment. It's the first time I had ever seen burst in the correct **rectangular** shape. When viewed in a TV receiver, ringing effects round the burst into a bell curve.

Rise time is so short that many of the vertical lines are invisible. In fact, it's difficult to tell where the negative-going sync pulses are located. Compare these waveforms with the following ones that have better visibility (but degraded response).

Usually, line 18 of Field #1 has a white flag followed by six envelopes of multi-burst in frequencies of .5 MHz, 1.25 MHz, 2.0 MHz, 3.0 MHz, 3.58 MHz and 4.1 MHz (left to right). The waveforms of Figure

3 were photographed at a local TV station and show the VITS from the network feed. The main purpose of this pattern is to show relative frequency response, so identical amplitudes and sharp corners are desired. Notice the raggedness of the envelopes, the slight overshoot at the trailing edge of the horizontal sync, and the missing 4.1-MHz burst. (This amount of degradation is acceptable.)

Line 18 of Field #2 has a white flag, followed by six envelopes of the NTSC color-bar test pattern (100% saturated colors at 75% amplitude), and then a black bar at setup level. If this pattern were repeated for all visible lines, it would give six bars of color on a color receiver. But it only exists for 1 line out of the 525, so it is observed on a vectorscope (Figure 4) as a test of correct amplitude and phases (tints) of the chroma part of the video signal.

Field #1 line 19 has a five-riser staircase, each riser with a color subcarrier of the same phase as burst (used to determine dynamic gain, plus differential gain and phase), a 2T sine-squared pulse (giving an indication of transient response), a 12.5T pulse-modulated 3.58-MHz subcarrier (for measurements of chrominance/luminance delay, and the amplitude response at 3.58 MHz), and a white bar or flag which tests for low-frequency phase characteristics.

Usually, the same waveform is added to line 19 of Field #2. However, stations are permitted to use this line for test signals of their own choosing, perhaps for testing another part of the system.

VITS in a receiver

Figure 5 shows a complete set of VITS from a "typical" color-TV as viewed on a dual-trace scope. If you thought the network VITS were poor quality, just compare them with these! There's too much amplitude at about 1 MHz, with fall-off above that point. According to the amplitude of the 12.5T pulse, the response is down about 40% at 3.58 MHz. But remember that the alignment curve for this TV is supposed to have the color carrier (3.58 MHz in chroma or video) at the 50% point on the curve, so perhaps that's slightly better than the average receiver response.

Perhaps this makes clear why the VITS analysis is not recommended for use with receivers.

VIR Signal

After five years of research and field testing by many segments of the broadcasting and manufacturing industries, and a formal proposal by Electronic Industries Association (EIA) to the Federal Communications Commission, the FCC formally has adopted in Docket 19907 the specifications for a Vertical-Interval Reference signal.

According to C. Bailey Neal, chairman of the Broadcast Television Systems Committee, the VIR signal will allow television broadcasters more precise control over the color balance of color broadcasts. **Eventually, it could mean the elimination of color-adjustment controls on home television receivers.**

The FCC order provides a one-year transition period for stations now transmitting VIT signals on lines 18 and 19 to obtain equipment for lines 17 and 18, thus vacating line 19 of both vertical fields for exclusive use of the VIR signal.

VITS Versus VIRS

The basic purposes of VITS and VIRS are completely different, as are the uses. VIT signals are diagnostic test signals for evaluation of devices or facilities, and are not associated directly with any individual color program. Each VIR signal is associated with a specific TV program to permit checking the parameters of that one program and showing which corrections are required to improve any sub-standard conditions. These signals are inserted into the video as soon as possible following the point where the correct amplitudes and phase of the composite color signal have been established.

Following insertion of the VIR signal, it must be treated exactly the same as the program material, and remain with that video until it is broadcast (VITS can be inserted and erased as required). Therefore, when adjustments are made to restore the **VIR** signal to the proper characteristics, the color quality of the **program** also will have been restored correctly.

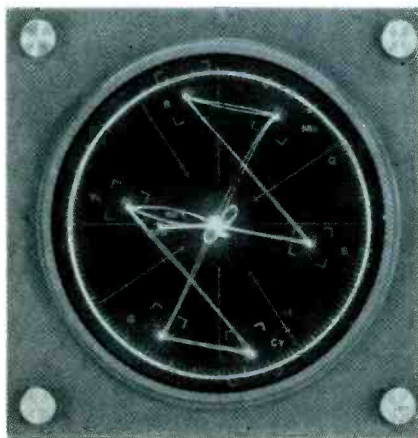

Fig. 4 A VITS vector pattern for the six NTSC color bars can provide a precise phase reading.

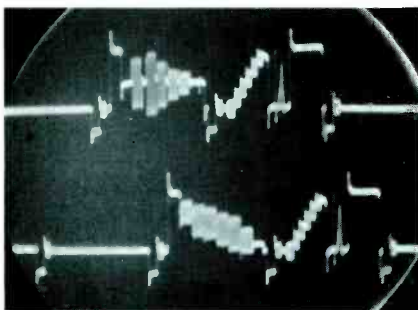
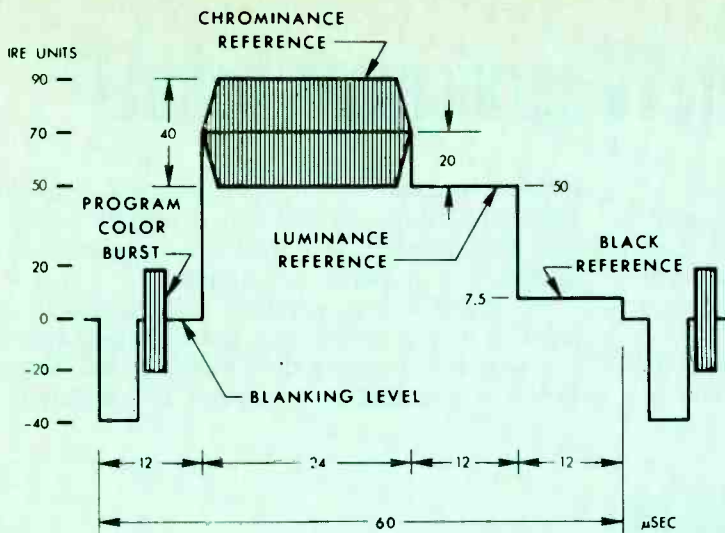

Fig. 5 These dual-trace VITS waveforms were taken from a color TV of average quality. The burst amplitude is low, the multi-bursts show an uneven frequency response, and there is some overshoot at the beginning of pulses. But remember, the alignment curve of all color sets provides for a sharp cutoff above 3 MHz. That's one reason the VITS waveforms are of questionable value in testing receivers.



NOTE: THE CHROMINANCE REFERENCE AND THE PROGRAM COLOR BURST HAVE THE SAME PHASE.

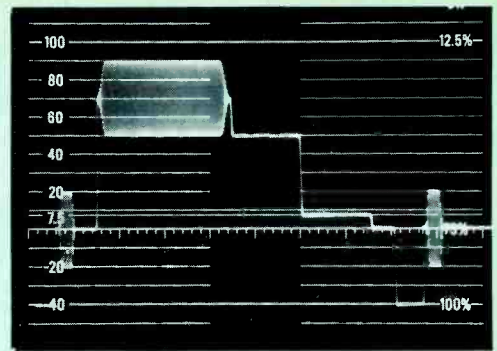

Fig. 6 Here is a drawing of the new VIR signal and an actual scope waveform from a VIR generator. It is a simple signal, but it permits the correction of many things, such as burst phase and the ratio of color to b-w, while the program is in progress. This should eliminate any significant variations of tint and color saturation between different channels and colorcasts.

Elements Of VIRS

The broadcasting industry and manufacturers have expended thousands of man-hours and years of testing to obtain the very best VIR signal. So, it's a little startling to see the extreme simplicity of the signal (Figure, 6).

However, the very simplicity helps the ease with which the waveforms can be generated, observed, and interpreted. And the format minimizes any reduction of its usefulness when subjected to transmission distortions.

Despite the few elements of the VIR signal, much useful information can be extracted from it. Amplitude, frequency (3.58 MHz), and phase of the color burst and the chrominance-reference envelope are identical. Quite often in network lines or in video-tape recorders, the program burst is keyed out and clean burst re-inserted. This allows the possibility of burst phase becoming different than the phase of the chrominance signal. If uncorrected, the result would be wrong hues, or the need for the viewer to readjust the tint control.

Now, the advantage of VIRS becomes apparent. Any differences of either phase or amplitude of the program burst compared to that of the chrominance-reference envelope can be identified by viewing the

VIRS on a **vector display** (they should overlap). The station engineer then tweaks the burst amplitude and phase until they are identical to those of the chrominance-reference part of VIRS.

When this simple task is done properly, no adjustments of the receiver tint controls are necessary; tint is the same as it was during the setup adjustments at the original broadcast. **Goodby, tint control!**

Inclusion in the VIRS of the luminance-reference level and the black reference makes possible the correct balancing of these two important conditions with the amplitudes of horizontal sync and burst. (Here, as in the non-vertical-interval part of the video signal, the burst amplitude should be equal exactly to the amplitude of the horizontal sync measured from the top of the blanking pedestal.)

The bottom of the chrominance-reference envelope should be in line with the luminance-reference level (if the signal has not traveled through non-linear circuits), and this gives a quick check of the relative chrominance-to-luminance ratio.

For these tests, the station engineer uses a **scope waveform** of the VIRS as a guide and operates a stabilizing or processing amplifier to correct for any errors. **Goodby, color control!**

Frosting On The Cake

It is expected, as the use of the VIR signal increases, that the TV stations will obtain new equipment which will sample the various VIR parameters and automatically correct each program signal to its original amplitude and phase characteristics.

Such automatic devices would provide continuous monitoring and make corrections so rapidly that the viewers would not be aware of any change.

Summary

VITS (for the diagnosis of video defects) have been used for several years. Now, they are being supplemented by the Vertical-Interval-Reference signal that makes possible restoration of the original color quality of TV programs **before** they are broadcast.

I have not seen the VIR signal on any of the programs these past few months, so it appears the use on a regular basis has not been initiated as yet.

When VIRS is in regular use, very few adjustments of tint and color controls should be necessary, even when you change channels.

Then, if this proves to be the case, it's logical to expect new models of color receivers to have the color and tint controls removed, or placed in hidden locations. □

"I never saw a lady TV serviceman before!"

Three energetic and ambitious women in the area of Allentown, Pennsylvania have succeeded in the male-dominated field of TV servicing. Although all three enjoy their work, they agree that patience is as necessary as technical competence, because a problem cannot always be found immediately.

It's likely many male eyebrows were raised in astonishment and disbelief when these ladies started

their careers, but now they are accepted cordially by other technicians. In addition to service work, they also sell electronic products, answer calls from consumers, and do other related tasks.

All of the women obtained their technical knowledge by on-the-job training and by attending service seminars conducted by the Charles L. Bell Company (Allentown distributor for Quasar TV receivers).

Even bad weather doesn't stop Sharon Mullins from loading her television-service caddy aboard the van and starting the day's round of calls. Sharon is employed by Seltzer TV Electronics and Appliance Center in Ashland, Pennsylvania.



Sharon Mullins—When she was 12 years old, Sharon Mullins decided her career should be in TV servicing. She would visit the Golden L. Seltzer TV Electronics and Appliance Center in Ashland, Pennsylvania, and watch the technicians servicing TV receivers. Now, at the age of 21, Ms. Mullins is working for Seltzer in that same shop.

"On-the-job experience is the best teacher," said Ms. Mullins, who recommends the service field to other women who have aptitude and a desire to learn.

Mrs. Loretta Mack (wife of Bob Mack, owner of Mack TV and Appliance Center of Pen Argyl, Pennsylvania) is pictured replacing a panel in a Quasar color TV. She wanted a different and challenging career, and found it in servicing television receivers.



Loretta Mack—Loretta Mack entered the electronics field 5 years ago, because she wanted a different and challenging career. Mrs. Mack learned servicing methods from her husband, the owner and manager of Mack TV and Appliance Center in Pen Argyl, Pennsylvania, and now repairs both color and b-w TV.

"We needed help when our sales and service shop was opened, and it seemed logical for me to learn how to service television receivers," she said. Mrs. Mack knows there is a shortage of good technicians, and recommends that more women enter the field. She feels women should not be afraid of the business, or discouraged by the knowledge required.

Adjusting TV's after repairs is one of the varied tasks performed by Mrs. Elva Treible, of Treible TV Sales and Service, Stroudsburg, Pennsylvania.



Elva Treible—A diagnostician in the service field for 22 years, Elva Treible of Treible TV Sales and Service, Stroudsburg, Pennsylvania, learned the trade from her husband. She diagnoses TV troubles, and assists her son or husband in TV repairs.

Mrs. Treibel finds that most women are amazed to answer their doorbells and find a woman service technician.

"Boy! I never saw a lady TV service man, but I always wanted to be one!" exclaimed one customer. □

Build an adapter for testing unmarked transistors

By Leonard J. Eisner

Do you need a fast way of identifying the leads of unmarked transistors? Or a simple tester that will give you items of information not supplied by your commercial transistor tester? Then perhaps you should build this adapter. The adapter and your ohmmeter measure transistor junction resistances (an old method), but with switches to indicate polarity and save much time otherwise required to change connections.

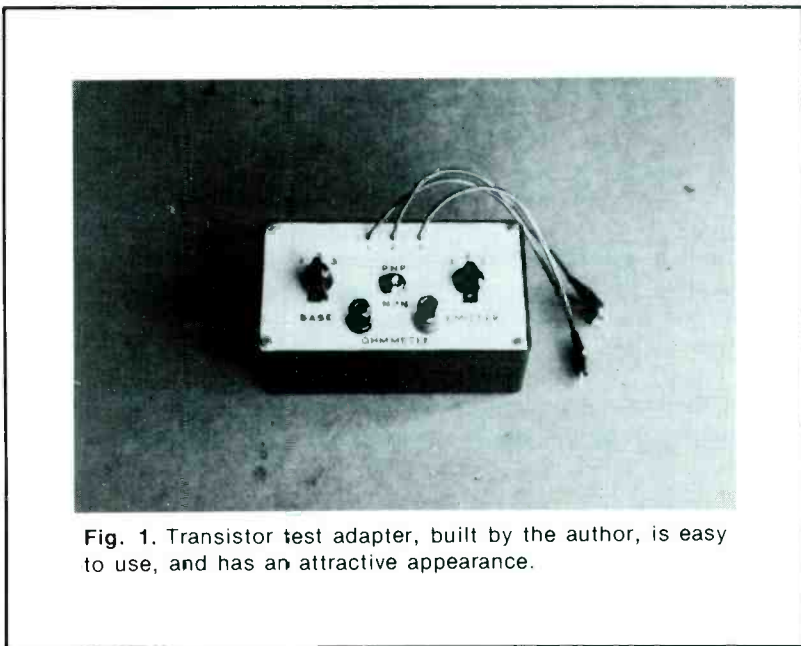

Fig. 1. Transistor test adapter, built by the author, is easy to use, and has an attractive appearance.

Most technicians occasionally need to identify the lead connections of unmarked transistors. Of course, this can be done with commercial testers, but usually it is a slow process of trial-and-error. Resistance measurements offer a promising alternative. However, there are some mechanical problems.

Drawbacks Of Resistance Tests

Ohmmeter test leads seldom have the small insulated clips necessary for secure connections without the danger of shorts. It's awkward and slow to connect transistor and ohmmeter in the six different configurations, plus the difficulty of remembering the readings and the identifications they represent.

For some time, I have used (between transistor and ohmmeter) a home-built adapter that permits complete resistance tests of an out-of-circuit transistor, without the bother of reconnecting the leads for each test.

Resistance-Test Adapter

Figure 1 shows the appearance of the adapter unit I built to make transistor resistance tests easier. Other layouts are possible, as described later.

These are the transistor tests made by the adapter and ohmmeter:

- identifies base, emitter, and collector leads;
- provides six readings of junction opens, shorts, and leakages;

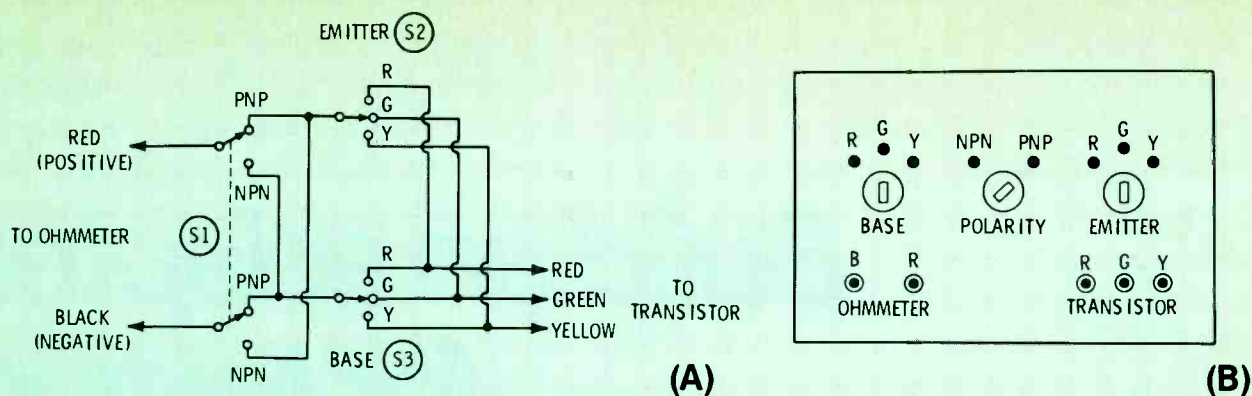

Fig. 2. Layout of parts and wiring is not critical; here are some suggestions. (A) This is the schematic, using colors for easier identification. (B) Make up your own physical layout, perhaps with the switches along the bottom so it isn't necessary to reach over them.

- determines the transistor polarity, whether PNP or NPN; and

- indicates whether the transistor material is germanium or silicon.

Best accuracy is obtained by testing out-of-circuit; although it's usually possible to identify the base, and make a few other tests, if the circuit resistances are high enough.

Of course, beta, linearity, and "reach-through leakage" are not measured, but it is amazing how many bad transistors can be found this way. And after the leads have been identified, you can test any transistor, whose condition still is in doubt, by using a more-sophisticated instrument.

Building the Adapter

Physical layout of the switches and wiring (Figure 2) is not critical. It's preferable to build it in a small plastic or metal box. But make it large enough for easy handling of the knobs.

Testing Ohmmeter Polarity

Voltage for the test comes from the ohmmeter; there are no batteries in the adapter. Therefore, the polarity of voltage present at the ohmmeter test leads must be known. If the polarity is wrong at the adapter, the PNP and NPN indications will be reversed.

Most tube-type VTVM's supply negative to the common (ground) lead, and positive to the shielded lead (hot lead). However, other meters could have either polarity; the only satisfactory way is to

measure it. That's easily done with a separate voltmeter.

Finding The Base Lead

Follow these steps to identify the base lead:

- Connect the correct polarity of ohmmeter leads to the terminals of the test adapter, and select the **X10** scale. Adjust the transistor-polarity switch of the adapter to the **NPN** position;

- Connect any color of tester wires to any leads of the transistor to be tested (ignore the shield or 4th wire, if there is one);

- Set the **Base** switch to the **Red** position;

- With the **Emitter** switch, try the **Green** and **Yellow** positions, noticing the approximate resistance at each;

- If both readings are low resistance, the base is connected to the **Red** wire.

- If both readings are **not** low, you have not yet found the base lead;

- Set the **Base** switch to the **Green** position;

- With the **Emitter** switch, measure the resistances at the **Red** and **Yellow** positions;

- If both readings are low resistance, the base is connected to the **Green** wire.

- If both readings are **not** low, you have not yet found the base lead;

- Set the **Base** switch to the **Yellow** position;

- With the **Emitter** switch, check the resistances at the **Red** and **Green** positions;

- If both readings are low, the base is connected to the **Yellow** wire.

If these previous tests have not given the desired results, there are **two** possibilities: **the transistor is defective** (open); or it is a **PNP type**.

Therefore, **change the polarity switch to the PNP position and repeat the steps given previously**. If those tests do not locate the base, the transistor is open, and no more tests are required.

If you select the same color of lead with both the **Base** and **Emitter** switches, the resistance reading will be zero. No damage is done, but don't confuse it with a normal "low" reading.

Testing For Leakage

There are two reasons why the amount of leakage across a transistor junction is important: it is one of several characteristics that tell us the transistor's condition; and excessive leakage can cause false conclusions during the base-location steps.

After you have attained what seem to be the correct switch settings to identify the base, it's

necessary only to turn the PNP/NPN **Polarity** switch to the opposite position, to test the B/E and B/C leakage. Try both settings of the **Emitter** switch that previously gave the low readings. This time, high resistances are desirable. If leakage of that particular transistor is important, switch to a higher resistance scale on the ohmmeter.

Any transistor with a junction that measures nearly the same resistance with both polarities is defective and needs no further tests. Such near-shorts can confuse you also in locating the base.

Germanium or silicon?

When you have found the base lead by the previous method, the polarity (PNP or NPN) also has been proven. Just one more step will tell you whether the transistor material is germanium or silicon. (This is important to know, because the forward bias requirements are widely different, and germanium normally cannot be used at higher collector voltages.)

When measured on the same range of an ohmmeter, the forward-biased junction of a germanium always will have a lower resistance reading than a silicon will. For example, a germanium might test 8 ohms on the X1 scale, while a silicon might measure 15 to 20, when both are tested with a VTVM that has a 1.5-volt ohmmeter battery. On the X1000 scale, a

germanium often tests around 1K, but a silicon usually checks around 4K to 5K. Higher ranges make the readings even less alike.

Check a few transistors of each type, and you'll be sure what the readings should be on your meter.

Finding Emitter and Collector

Because the diagram of a transistor is two diodes of opposite polarity in series (Figure 3), you would think that between the outside terminals (collector-to-emitter) there should be a very-high resistance, regardless of the polarity. That would be true if **no** leakage occurred across individual junctions. But leakage always is present, and the C/B and E/B leakages act as a resistive voltage divider to give the floating base a small voltage. This voltage is forward bias when the collector polarity relative to the emitter is the same as the base must have (relative to the emitter) for maximum B/E current to flow. When the polarity is reversed to collector and emitter, the base voltage relative to the emitter is reverse bias, which increases the resistance of the collector-to-emitter path.

This is true transistor action, and the test is a step above the testing of individual B/E and B/C junctions as diodes.

Those facts are the basis for the following tests to identify emitter and collector leads:

- Select the 1K scale of the ohmmeter;
- Turn the PNP/NPN polarity switch to the type established by the previous tests;
- During the previous tests, one color of lead was proved to be the base. The remaining two are the collector and emitter, but we don't know yet which is which;
- Turn the **Base** switch to one of those known to be either collector or emitter, and turn the **Emitter** switch to the other; notice the reading;
- Reverse the settings of the two switches (for example, if **Base** was

Red and **Emitter** was **Green**, change **Base** to **Green** and **Emitter** to **Red**); notice the reading;

- Rotate the switches again (if necessary) to give the **lower** of the two readings; now the color indicated by the **Base** switch is connected to the **collector**, and the color indicated by the **Emitter** is connected to the **emitter**.

Germanium transistors show a large difference of resistance during the previous test. For example, a small PNP germanium tested 1K on the X1000 scale when the collector was negative, and about 200K when the collector was positive relative to the emitter.

For silicon transistors, you should change to a higher scale (perhaps up to X1M for small transistors), or use a VOM with a higher battery voltage. One small silicon NPN, when the collector was positive, tested 200M on the X1M scale, and 800M with the collector negative relative to the emitter.

Collector/emitter leakage

In locating the collector and emitter leads, you have tested also the leakage of the C/E path (it is the higher of the two readings). After you have set the **Base** and **Emitter** switches correctly for the minimum resistance, just changing the polarity switch to the opposite position also measures the leakage.

Some transistors check normal as diodes from B/E and B/C, but have a near-short from collector-to-emitter; therefore, **it is very important to make both normal-polarity and leakage tests.**

Summary

Resistance tests of transistors neither provide the ultimate in accuracy, nor do they check all transistor characteristics.

However, if resistance tests indicate a certain transistor to be defective, you can believe it.

And with the adapter I have described, you should be able to identify leads rapidly, and obtain a preliminary estimate of the condition of many unknown transistors. Then for additional information, use your commercial transistor tester. □

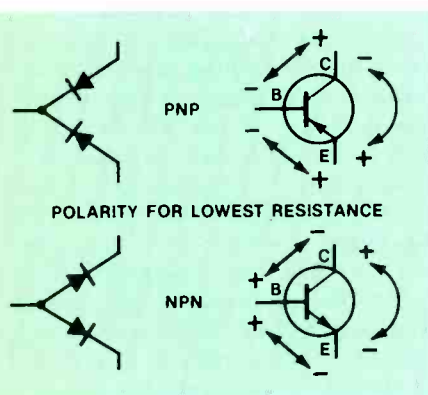

Fig. 3. Identification and testing of transistors are based on the response of the transistor junctions to the ohmmeter voltage according to the polarities shown. Three forward-bias tests and three reverse-bias tests are included.

BENCH PERFORMANCE IN YOUR POCKET



The Hickok Model 239 color bar generator has an exclusive MOS LSI chip which provides 9 Rock Stable patterns and low battery drain.

- Simplified operation with 2 matrix slide switches.
- Crystal controlled chroma and timing oscillators.
- RF adjustable Channels 2-4.
- Powered by 2 standard 9v batteries.

Plus our unique 2-year warranty.

The Hickok Pocket Model 239 or our deluxe bench Model 246 are values you have to see to appreciate. See them at your Hickok distributor or contact us for more information.

\$11500

HICKOK

the value innovator

INSTRUMENTATION & CONTROLS DIVISION
THE HICKOK ELECTRICAL INSTRUMENT CO.
10514 Dupont Avenue • Cleveland, Ohio 44108
(216) 541-8060 • TWX: 810-421-8286

For More Details Circle (8) on Reply Card

reader chuckles

Share with other readers one of your amusing incidents. Send a short write-up to the editor.

The Case of the Howling TV Set

By Mort Gordon

It was 4 o'clock in the afternoon of a slow day, and I was at the bench making minimal progress on a "dog" plagued with a multitude of problems. While slowly unraveling these problems one by one, I was comforted by remembering that ultimately even a tortoise crosses the finish line.

The phone rang, and the "hello" of my customer was drowned by static, high-pitched squeals, and the audio portion of a TV program. Thinking very bad thoughts about the maintenance of telephone equipment, I shouted that we had a bad connection, and could I have her number and call her right back? However, I soon realized that my customer was holding the phone next to the TV set and shouting "Can you hear it?". Finally, I persuaded her to shut off the set so we could communicate. No, I couldn't analyze the problem over the phone despite the fact I heard the defect; no, I wouldn't recommend using the set when an obvious malfunction existed; yes, I suggest a service call to resolve the matter; don't worry, I'll be right over so you can see tonight's programs!

My customer excitedly turned on the set for me upon my arrival, and sure enough there was the most awful yowling I have ever heard. Despite this fact, the audio portion of each channel was clear, undistorted, and responded correctly to the volume control. My customer persistently requested an instant diagnosis, and using my best poker face to mask my lack of knowledge as to the cause, I calmly and confidently (?) told her a little circuit analysis would soon disclose the source of the problem.

Fortunately, I left the set turned on as I slid the cabinet slowly forward to get enough working room behind the set. As I did so, the high-pitched yowling seemed to

change, and I remembered the Doppler effect. Shaking my head in disbelief, I noticed the **intensity** of the yowling was diminishing in direct ratio to movement of the TV set out of the corner! Approximately two feet away from the wall the yowling stopped completely.

I paused to reprogram my brain and digest this fact. It could be a microphonic first audio amplifier or output tube, and the vibration of outward movement momentarily had shocked it into silence. Sharp raps on the side and top of the set produced no telltale microphonic reaction. Why not move the set back into the corner while it is still playing? Magically, the symptom reappeared with an intensity variation in direct proportion to the distance of the set from its corner. This required more thought. Does that crazy "ham" across the street have some generator going? We definitely seem to be heterodyning. I bent over the top of the set to peer behind it, and there on the floor lay some school books and a small battered black box. I'd better investigate this.

Again, I moved the set away from the wall, and again the howling stopped. My customer stood transfixed. I moved behind the set and picked up the black box. As I moved it toward the TV set, the **box** started to yowl! It was a transistor radio left turned on, but with the tuning dial between stations, so it made no sound until the oscillators of the TV started to beat with it! I demonstrated the effect to my disbelieving customer.

At this point, the teen-aged daughter walked in from the kitchen. Yes, she always put her books behind the set after school. And of course her radio was turned off; she always turned it off the minute she walked into the house!

Since my astounded customer couldn't think of any other defect in the TV set that would require servicing, I made out my bill, gently talked her back into reality, and went back to my shop and the "dog". □

Servicing Modular Color

Part 2/By Charles D. Simmons



Operation of the horizontal-output stage of the 19EC45 Zenith is "conventional". That is, an oscillator drives an output transistor, which furnishes power for deflection and high voltage. Some characteristics are similar to tube-powered circuits, but many are just the opposite. The essentials for understanding and repairing the horizontal-sweep circuits are presented here.

Zenith color TV portables using the 19EC45 vertical solid-state modular chassis have the horizontal-sweep section located at the upper-right corner (Figure 1).

Most of the horizontal components either are on the 9-90 plug-in module, around the horizontal-output transistor on the large heat sink just above the module (Figure 2), or on the chassis behind those two areas (Figure 3).

Conventional components and plug-in transistors are used on the 9-90 module, giving the option of replacing the whole module or repairing the individual defect. However, the oscillator coil, driver transformer, horizontal-output transistor, and all other following sweep components are not on the module, as shown by the block

diagram of Figure 4.

Intelligent troubleshooting can be done only after the purpose and function of each circuit are thoroughly understood. Therefore, we'll analyze the circuits first, and then discuss diagnostic methods.

AFC Circuits

Details of the schematic at the left of the transistor in Figure 5 should look very familiar. They're almost a carbon copy of tube circuits. Even the waveforms are similar.

Two signals are necessary for any Automatic Frequency Control (AFC) circuit. One signal is the horizontal sync, consisting of differentiated pulses from the sync separator; the other is a sample of horizontal sweep, whose pulses are changed into sawteeth by a low-pass filter.

Although pulses can be integrated into sawteeth by a single-section low-pass filter (a series resistor, followed by a capacitor to ground), Zenith has done it in two steps with an amplifier/shaper in between.

Figure 6 is a picture of the 9-90 module, showing the locations of transistors and major parts.

Negative-going horizontal pulses of about 60 volts p-p from the flyback transformer (T206) are

rounded in waveshape and reduced to about 8-volts p-p by R808 and C804, before they are applied to the emitter of Q804, the sawtooth-shaper transistor.

Q804 operates as a grounded-base amplifier, that gives gain but does not invert the polarity. Forward bias is supplied by the negative pulses to the emitter (the same action as positive pulses to the base).

C803 and the collector/emitter resistance of Q804 act as another low-pass filter, making the sawtooth waveform more linear. The bias from pulses, and the losses because of the filter, give Q804 a gain of about 2. The 15-volt sawtooth signal at the collector of Q804 is coupled through C802 to the anode of CR801.

Horizontal sync of about 20-volts p-p from terminal W1 of the 9-87 video/sync/AGC module is differentiated by C801 and applied to the common cathodes of CR801 and CR802, which seem to be germanium diodes.

Rectification by CR801 and CR802 of the sync and sweep signals is a complex combination of peak-reading shunt and series rectifier circuits. For troubleshooting, keep these facts in mind:

- When there is no sync (for example, when tuned to a blank

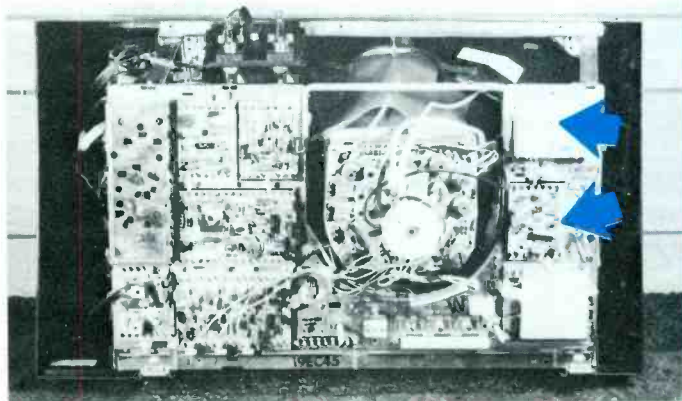
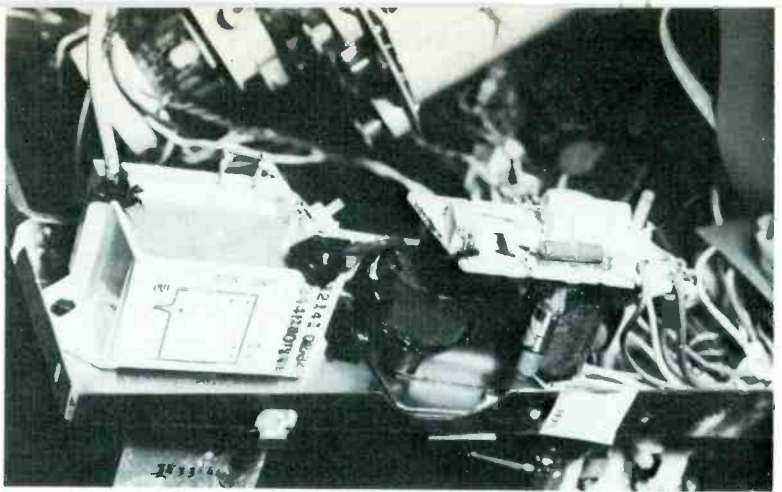

Fig. 1. Horizontal sweep components of the Zenith 19EC45 chassis are located near the upper right corner of the chassis. Module 9-90 and the output transistor (on a heat sink) are on the outside of the chassis. Flyback, HV tripler and other components are on the other side.

Fig. 3 Access to the tripler and the flyback (on the right) can be gained by loosening screws and tilting back the chassis.



channel), but with sweep sawteeth at the anode of CR801, a positive voltage is developed at the common cathodes, and the DC voltage at the anode of CR801 is nearly zero;

- If sync pulses are there, but the sweep sawteeth are missing, a positive DC voltage is developed at the common cathodes, and the anode of CR801 is almost zero;

- Normal operation with both signals produces a positive DC voltage at the common cathodes, but the DC voltage at the anode of CR801 is zero **ONLY** when the two signals have the same frequency and the desired phase. A variation of phase between the sync and sweep signals produces either a negative or a positive voltage at the anode of CR801.

Think of the two diodes as the sources of two equal DC voltages of opposite polarity. When both are equal, they cancel and the output from the anode of CR801 is zero. Otherwise, the output is positive or negative, depending on which source is dominant.

This output voltage is filtered to prevent overshoot and hunting (Figure 7) and then is used to control the horizontal oscillator, bringing it back into phase with the sync anytime frequency drift occurs.

Controlling the frequency

Sine-wave oscillators (such as those in 19EC45 chassis) are too stable for the frequency to be controlled by variations of grid bias (as is done with multivibrators). Instead, the DC voltage from the phase diodes determines the forward bias of Q801, the AFC transistor; and the bias establishes a certain collector/emitter resistance. This resistance and C809 in series are part of the oscillator tuned circuit. In other words, variation of frequency is by a variable resistance in series with a tuning capacitor.

Most of the base forward bias for Q801 comes through R805, but it is supplemented by some current through R809 from the collector. Now, this seems to be a mistake, for the collector has no visible way of obtaining a DC voltage (except perhaps from the base). The unique thing is that CR803 rectifies the part of the oscillator signal coming back through C809, producing more than +5 volts DC at the collector of Q801.

Oscillator Circuit

Basically, the oscillator is wired

as a common-collector type, with feedback for the base coming from the emitter, which connects to a tap of the oscillator coil (Figure 8). This is similar to the AM oscillator circuits in many of the older radios using tubes.

An adjustable core of L204 (oscillator coil) functions as the horizontal-hold control. No other variable control or adjustment is provided; the tuned oscillator coil makes a stabilizing coil unnecessary.

Signal from the emitter of the oscillator transistor (Q802) goes to the base of Q803, the driver transistor, in a roundabout way. Of course the emitter of Q802 goes to a tap on L204, but the low end of the coil is not grounded. Instead the emitter current flows through R814 on its way to ground. This provides a voltage waveform of the emitter current, and it is direct coupled to the base of Q803.

Two important facts should be noted here. The waveform is not a sine wave from the tuned circuit, but is more of a square wave because it's produced by the emitter current of Q802.

Secondly, any voltage drop across R814 is the forward bias of Q803. The 15-ohm emitter resistor (R819) is too low in value to offer very much stability or protection. So, any defect in the oscillator that significantly increases the emitter current might cause the destruction of Q803.

Driver Circuit

As is common with similar circuits, Q803, the driver transistor, is a medium-power type (but without any extra heat sink) that normally runs warm. Dissipation in

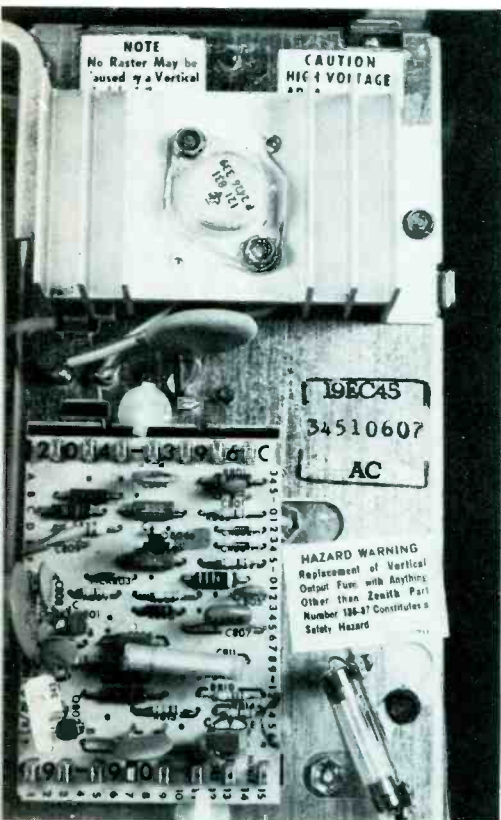

Fig. 2 This is a closeup of the horizontal-sweep area. The fuse is in the vertical circuit.

Q803 is about 5 watts (70 volts at about 70 milliamperes), and not much overload can be tolerated before the transistor might blow.

Some protection is obtained by bringing the collector voltage through R222 (800 ohms) from the +130-volt supply. Therefore, the more collector/emitter current, the less collector voltage is available.

Driver transformer T204 is a step-down type to match the low base impedance of the horizontal-output transistor; a fact of some importance when you are checking the peak-to-peak voltages there. Damping is applied to the primary by the series connection of C812 and R821. Expect the waveform to be quite raw, if either should open. Also, there is a chance the additional spikes might puncture the collector of Q803.

T204, R222 and most of the parts from this point on are not on the 9-90 module, but are on one side or the other of the chassis.

Insufficient drive

Strangely enough by tube standards, insufficient drive from the driver to the horizontal-output transistor gives a narrow picture with violent foldover near the center of the screen (Figure 9). And if the condition persists for more than a few seconds, it's likely the output transistor will fail.

Horizontal Output Circuit

Drive signal at the base of the horizontal-output transistor (Q202) is only about 8 volts p-p. DC voltage at the base is about -1.1 volts, with about -.9 at R224 on the other end of the driver transformer. This base voltage appears to be cut-off bias, rather than the required forward bias. However, this is typical of oscillators and other stages whose main bias comes from the AC signal at the base. And that's the case here; base current produced by the drive signal causes rectification, with C227 the peak-reading capacitor. Of course, the drive signal rises above this average voltage to make the base positive and turn on the collector current.

Another peculiarity is the waveform at the base (Figure 10). It takes a lively imagination to accept that weird waveform as normal, when at the collector of the driver it was a square wave with a small spike at one corner. However, it makes more sense to know that, with the output transistor removed, the drive waveform (Figure 10) somewhat resembles the sawtooth required for tube circuits. Perhaps the base current flattens the sawtooth, and the ringing and other distortions might be fed back through the internal capacitance of the transistor from the signal at the collector.

Is the transistor a switch?

Some writers have said the output transistor functions as a switch (see the circuit of Figure 11), implying that the current either was off or at maximum according to the part of the cycle.

The assertion is disproved by the waveforms shown in Figure 12. It's clear (even allowing for some distortion of the waveforms because of the added series resistances) that the collector current is roughly a sawtooth that deflects the CRT beams to the right edge of the raster, and that the damper current is a narrower negative-going sawtooth producing deflection for the left edge of the raster. The sudden cut off of collector current starts ringing which generates the large positive-going horizontal-sweep pulses we are so familiar with (damper conduction clips off the negative-going part of what otherwise would be a sinewave of ringing). These actions seem very similar to those of tube circuits.

Why All The Paralleled Capacitors?

Paralleling collector and emitter of the output transistor are about a half dozen capacitors, and their total capacitance tunes the yoke/flyback circuit. More capacitance lowers the ringing frequency, gives

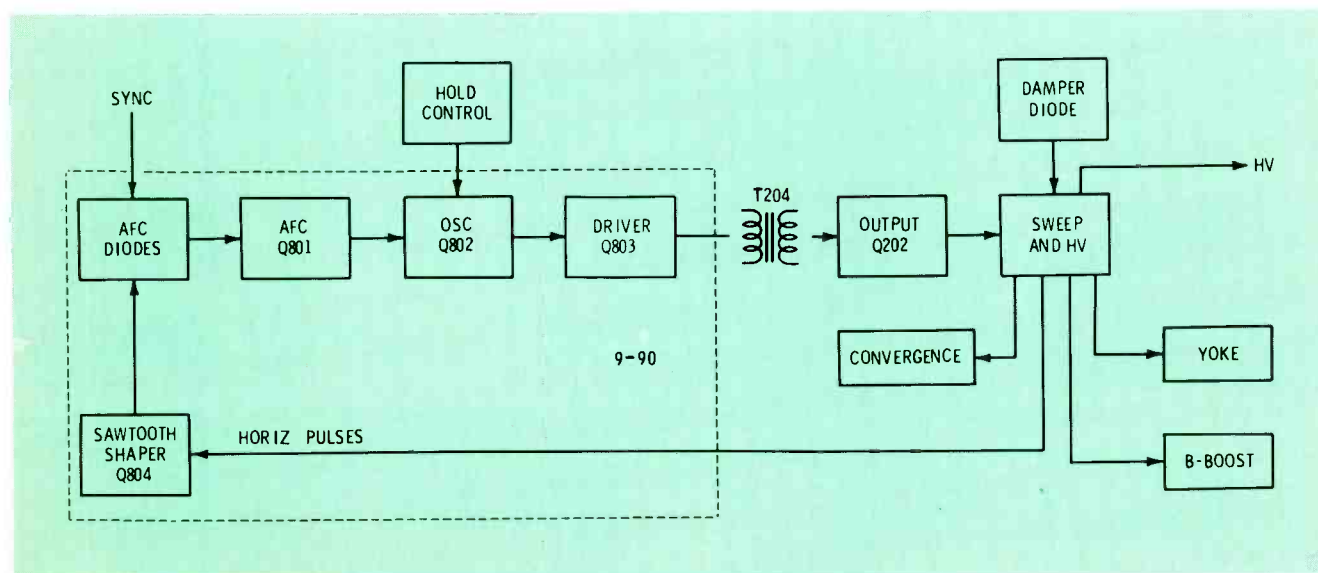

Fig. 4 Major horizontal-sweep components, both on module 9-90 and on the main chassis, are shown in this block diagram.

less amplitude of HV pulses, and reduces the DC high voltage. But, that still doesn't explain why so many are used rather than one having the same total capacitance.

Suppose one of those capacitors opened. The HV would rise, but by only about 500 volts; not enough to matter much. However, if only one capacitor was used, and it opened, the HV would go up almost 3KV, and the increased voltage could be the source of a radiation hazard. In this case, six small capacitors offer a better margin of safety than is possible with one large capacitor.

Changes in the 1975 models

In the later 17FC45 and 19FC45

chassis, most of the individual capacitors have been replaced by one special safety capacitor. The danger of any capacitor or capacitors used for this purpose is that it might open (or some misguided technician might remove one or more). Zenith has solved these possibilities very cleverly by supplying a single, large capacitor with two leads at each end. Then, as shown in Figure 13, the circuit wiring is in series with these ends. If the capacitor opens, or is removed from the circuit, one side or the other of the horizontal-output transistor and damper is opened, thus stopping all horizontal deflection.

Boost voltage source

CR212 rectifies the horizontal sweep pulses to produce the +700-volt supply, used mainly for the picture-tube screen-grid supply.

HV And Focus Voltage

High voltage is rectified by the multiple diodes inside the HV tripler assembly (CR214). An internal bleeder resistor drops the voltage down to the amount needed for focussing, with the precise voltage determined by adjustment of R237, the variable-focus control.

Also, from the HV tripler comes the waveform needed for the brightness-limiter operation, which will be discussed in a later article.

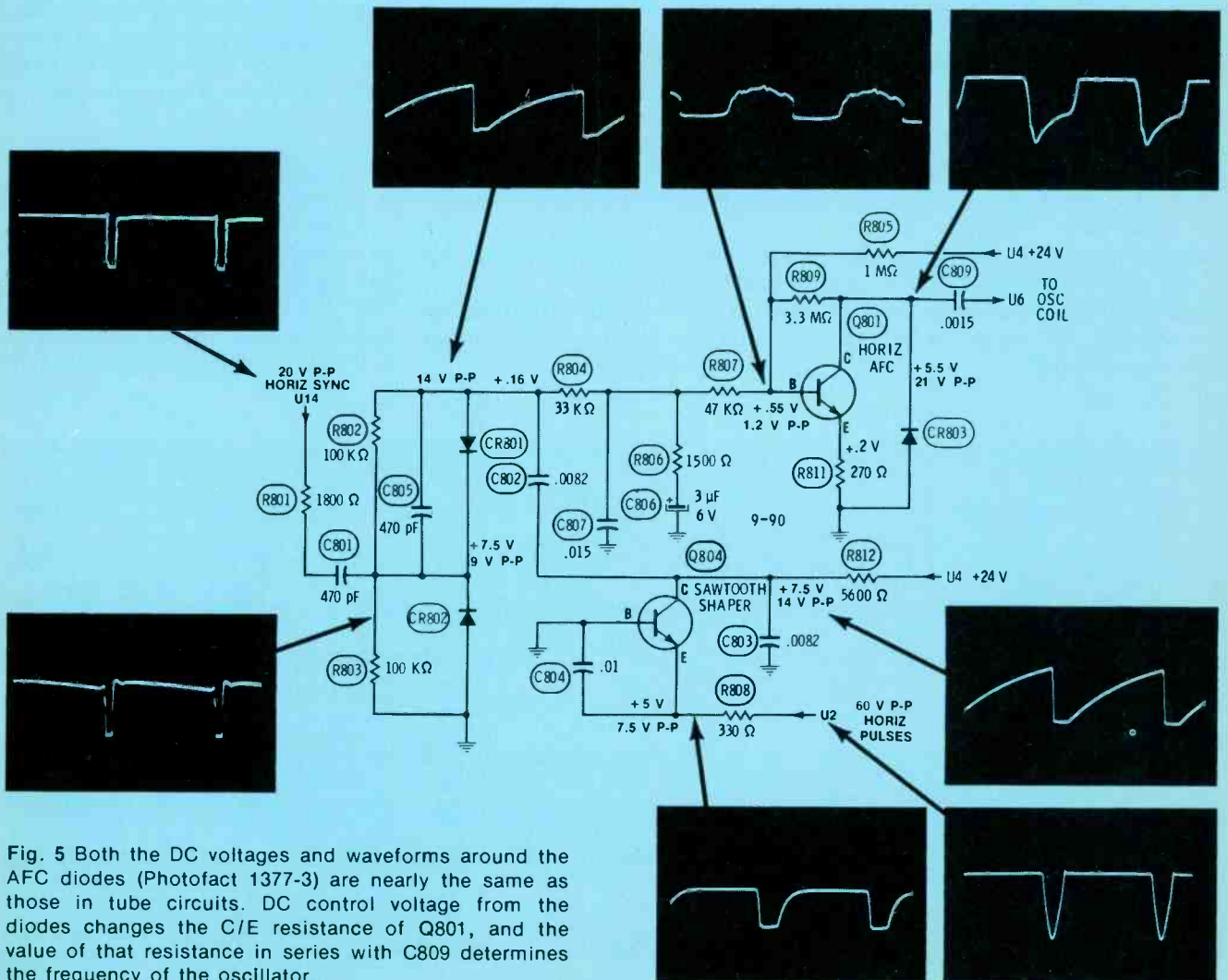

Fig. 5 Both the DC voltages and waveforms around the AFC diodes (Photofact 1377-3) are nearly the same as those in tube circuits. DC control voltage from the diodes changes the C/E resistance of Q801, and the value of that resistance in series with C809 determines the frequency of the oscillator.

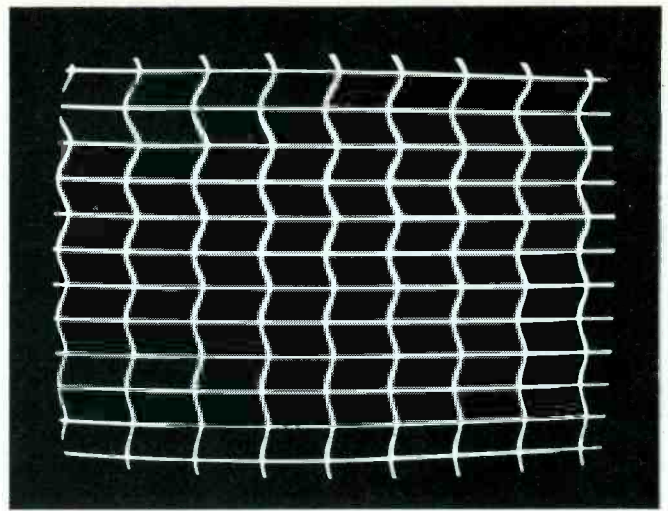
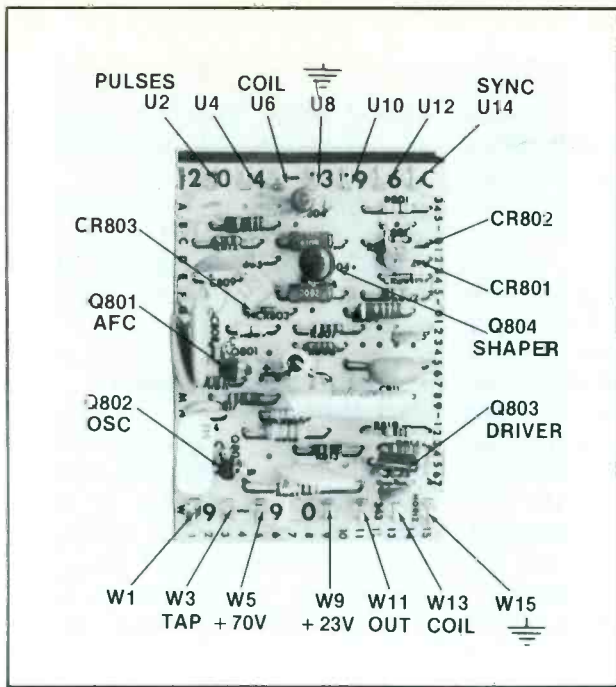

Fig. 6 Transistors, major components, and terminal numbers of the 9-90 module are pointed out on the picture.

Fig. 7 "Hunting" with a cross-hatch was caused by an open C806. Sometimes the effect is called "pie-crusting".

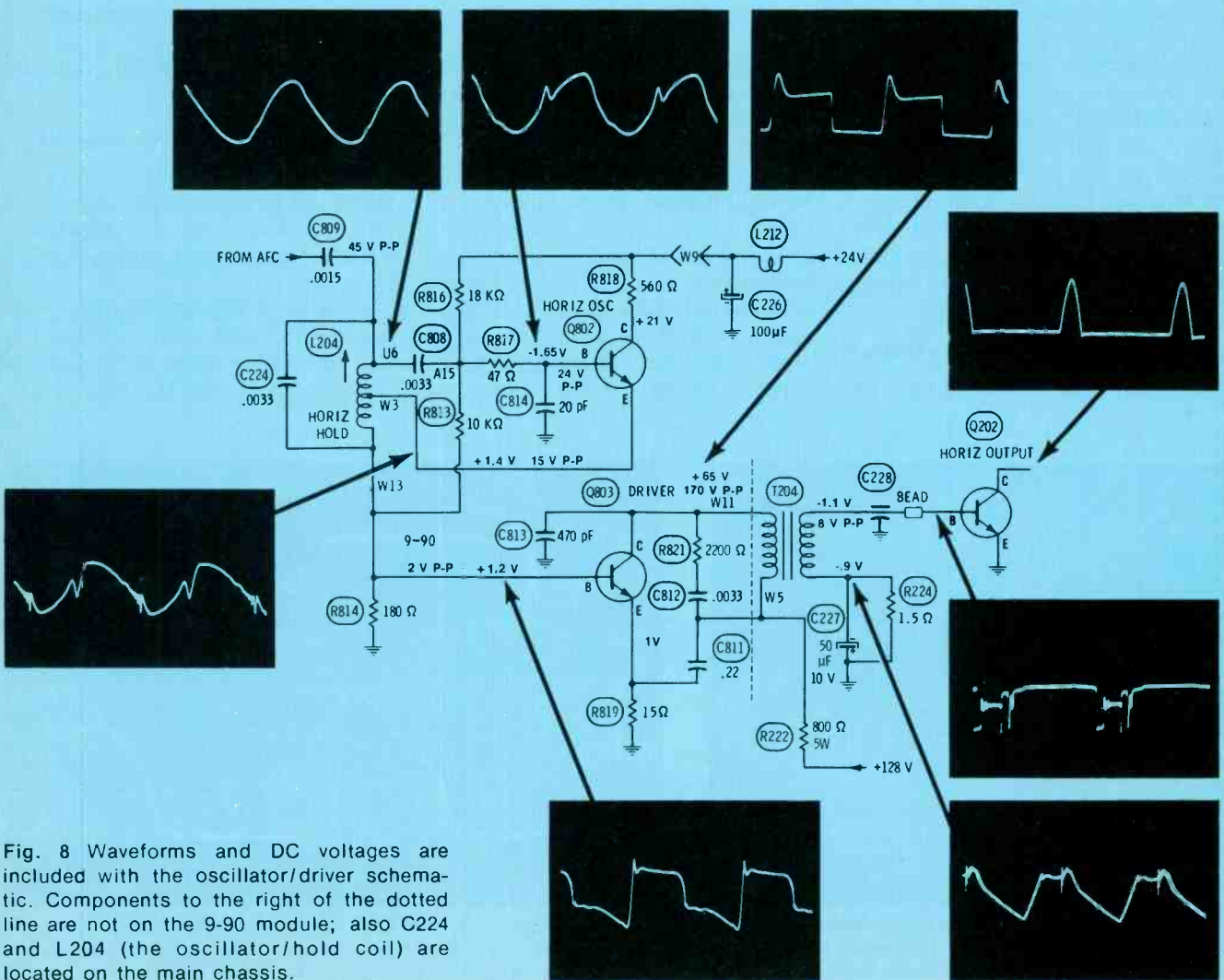

Fig. 8 Waveforms and DC voltages are included with the oscillator/driver schematic. Components to the right of the dotted line are not on the 9-90 module; also C224 and L204 (the oscillator/hold coil) are located on the main chassis.

Side-Pincushion Circuit

A simplified version of the side-pincushioning-correction circuit was given as part of Figure 11. However, the complete circuit (Figure 14) is not much more complicated.

Signal from the vertical sweep is brought in through R205, then the amplitude is reduced by C241 and C239 connected as a capacitive voltage divider which supplies the primary of T1302. Some DC current from the -35-volt supply sets the correct inductance of T1302 (a saturable-reactor). The combination of the vertical waveform and the DC causes the impedance of the secondary to vary at the vertical rate; and the secondary is in series with the cold side of the horizontal yoke. Therefore, the width is reduced at the top and bottom to eliminate the pincushioned effect at the right and left sides.

Troubleshooting is fairly easy. If a defect in this circuit is suspected, just connect a jumper wire across the secondary of T1302. Return of pincushioning and elimination of any undesired conditions means the defect is in the side-pincushion-elimination circuit. The circuit is much easier to understand when drawn by itself, instead of being included with all the other circuits and plugs.

Top/Bottom Pincushion Circuit

Pincushioning at the top and

bottom is minimized by filtering horizontal-sweep pulses and adding them to vertical sweep so the height is increased near the center of the picture (Figure 15).

The primary of T1301 (also a saturable reactor) is supplied with horizontal pulses from the flyback. R1307, across the secondary, determines the amplitude of the correction, and L1301 (tilt), C1203, and C1304 filter the pulses and adjust the phase. This filtered waveform is applied in series with the two vertical yoke coils, at the midpoint. R1304 and R1305 damp out any tendency of the yoke coils to ring.

To eliminate the effect of the entire circuit for test purposes, just connect jumpers across C1304 and C1305. Any improvement is proof of trouble in the top/bottom pincushion-elimination circuit.

Troubleshooting AFC

Symptoms of defects in the Automatic Frequency Circuit (AFC) are the same as in tube circuits with dual diodes.

Complete loss of either the horizontal sync at the cathodes of CR801 and CR802 or the sawteeth at the anode of CR801 will prevent locking, or make it a very-critical adjustment. Low-amplitude sawteeth probably would be caused by a defective sawtooth shaper (Q804).

An open or shorted CR801 or

CR802 would force the oscillator far out of lock with many diagonal stripes (Figure 16).

If Q801 is open or shorted, the raster might show 10 to 20 horizontal stripes. A defective diode CR803 produces about the same symptoms.

Eliminate the phase detector

Perhaps the fastest way of proving whether or not a defect is in the phase-detector part of the circuit is to ground the junction of R804, R807 and R806. No locking is possible; however, Q801 remains in the circuit, so adjustment of the horizontal-hold control (L204) should bring the picture almost into lock with only one or two diagonal stripes (Figure 17).

If the hold control will bring the oscillator that near correct locking with the control voltage grounded, but there are many stripes with it not grounded, a defect is in the diodes CR801 or CR802, or in the associated circuitry.

Troubleshooting The Oscillator

Frequency of the sine-wave oscillator is determined mainly by the inductance of the oscillator/hold coil (L204) and tuning capacitor C224.

However, C808, C809 of Figure 8, and CR803 and Q801 of Figure 5 also have some effect on frequency.

Field reports tell that the failure

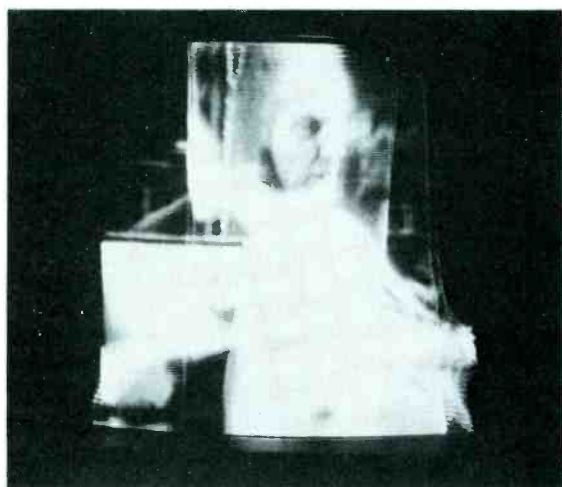

Fig. 9 A narrow picture with erratic shape and fold-over resulted from simulated shorted turns in the primary of T204, the driver transformer. About 30 seconds later the output transistor shorted out.

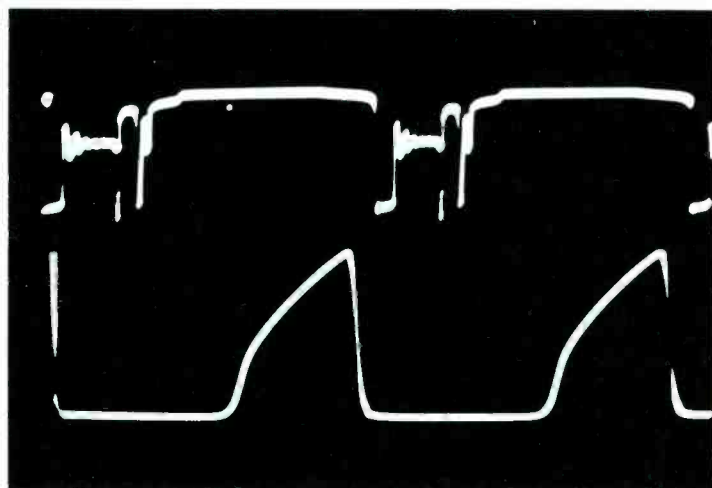

Fig. 10 Waveform at the base terminal of the output transistor (G202) changes radically when the transistor is removed. Waveform at the top is the normal 8 volt p-p one with transistor. After the transistor was removed, the amplitude increased and the waveform became a type of sawtooth (bottom trace).

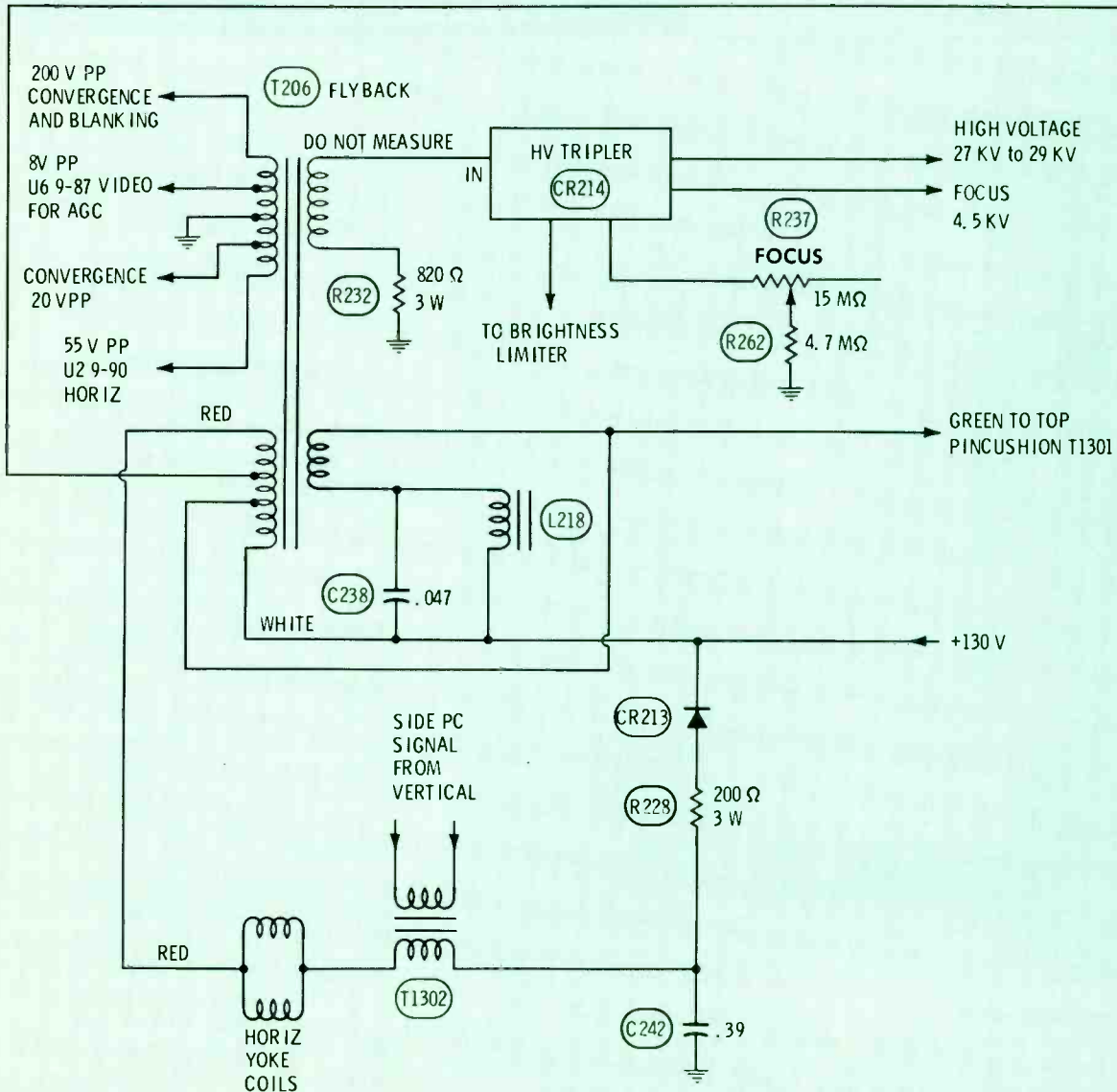
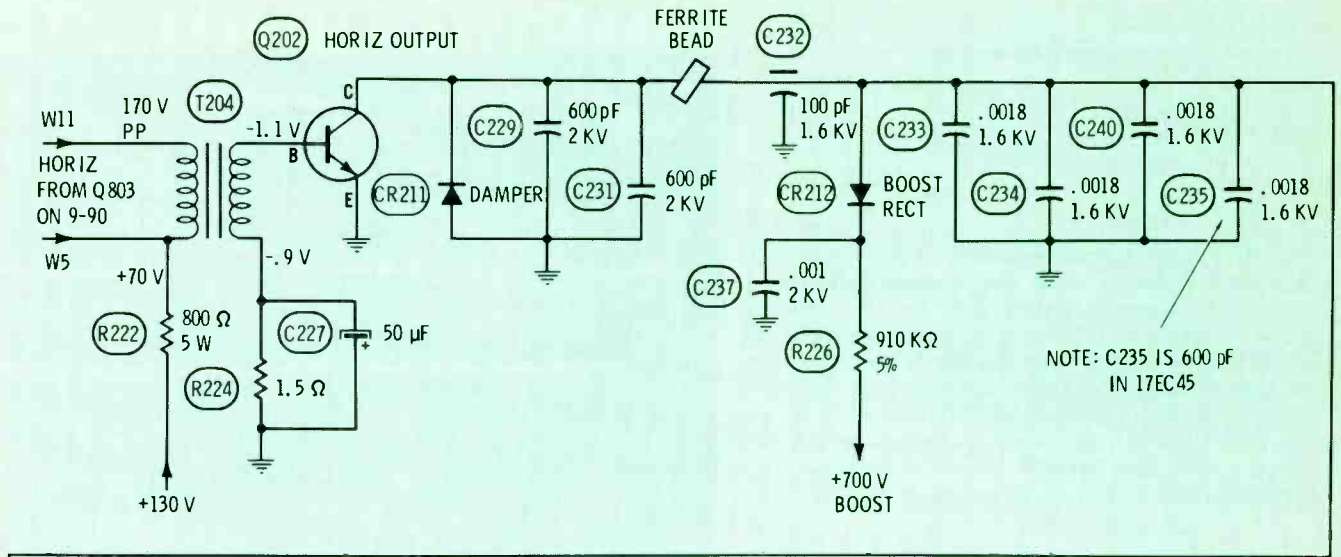

Fig. 11 Keep this schematic of the flyback and yoke circuit handy when you're troubleshooting; it's much easier to trace the wiring when the convergence circuit is omitted, and the pincushion circuits are simplified.

Fig. 12 These multiple exposures were made with the same phase to show the relationship between the various currents and voltages in the horizontal sweep. Top trace shows the waveform at the base of Q202; the second from the top is the waveform of emitter current of Q202 (deflection of the right edge of the picture); third from the top is the anode current of the damper diode (deflection of the left edge), and the bottom waveform shows the positive-going pulses at the collector of Q202.

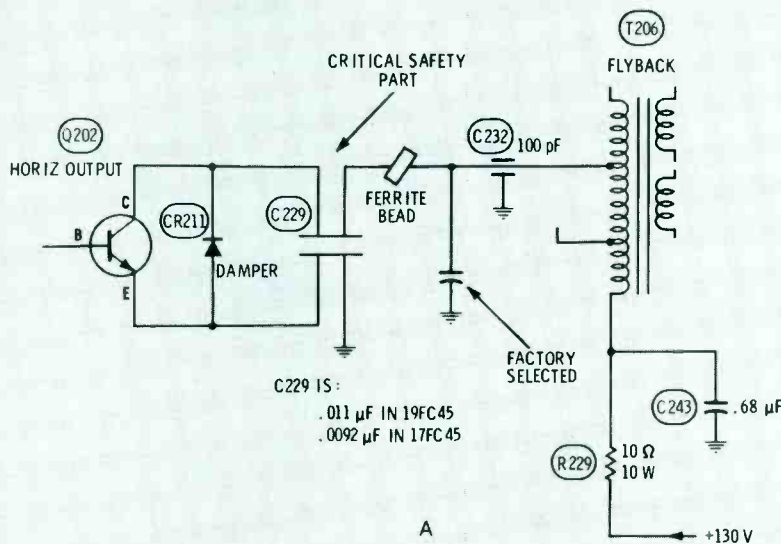
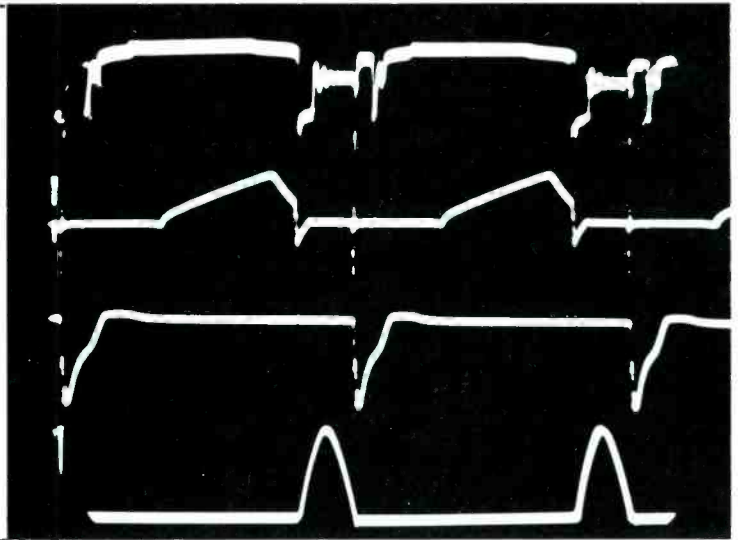

Fig. 13 In the 1975 models 17FC45 and 19FC45, the many individual capacitors which in previous models were connected in parallel between collector and emitter of Q202, are replaced by one special capacitor. (A) The circuit shows the capacitor has four leads, so the circuit goes through the capacitor. An open capacitor (or one removed) completely eliminates the sweep. Notice that the capacitor and the flyback transformer are not the same for the 17" and 19" models. (B) In appearance, the capacitor resembles conventional ones, except for the extra two leads.

of L204 in a few scattered cases has caused the output transistor to short out. If no other causes of Q202 failure can be found, suspect wrong oscillator frequency, or an excessive load on the flyback system.

Troubleshooting The Driver

The horizontal driver stage is a simple amplifier, so in most cases the troubleshooting is confined to checking waveform and DC levels at the base and at the collector.

Keep in mind that a C/E short in the oscillator transistor (Q802) would instantly ruin Q803, the driver transistor. Other defects that would increase the emitter current of Q802 (such as an open R813) are likely to destroy Q803. If you suspect such a problem, remove Q803 and measure the DC voltage at the base pin. Don't re-install Q803 until the base voltage is correct.

Of course, if correct signal waveform and amplitude are found at the base of Q202, the output transistor, there's little reason to check the driver stage at all.

But remember, if the base waveform of Q202 has smooth sawteeth (Figure 10), it's likely the transistor is open.

Drive Limits

Drive requirements for a hori-

zontal-output transistor are quite different from those for tubes. A tube without drive would be destroyed in time, perhaps a matter of minutes. **An output transistor without drive merely is cut-off**, without any collector current.

Maximum drive to a horizontal-output transistor is not very critical; the diode effect of the base just clips off the excess. But, drive above a certain minimum is absolutely essential.

Insufficient drive to the base of the output transistor can cause a narrow picture with a large foldover in the center (Figure 9). If this happens when you are watching, better turn off the power immediately; chances are the transistor will be ruined within a few seconds.

Perhaps the low drive doesn't force the transistor to be biased off long enough during each cycle, giving excessive **average** dissipation. And because the collector current starts too soon during each cycle, the damper current (deflection on the left) and the output transistor current (deflection on the right) partially cancel one another, causing the foldover.

at the base, is applied to Q202. Collector voltage comes right from the +130 supply. It's a simple circuit with few parts around the transistor. Just make sure the base drive is sufficient.

But there are a couple of peculiarities that come with solid-state. First is the damper diode. Its function is to clip any negative-going collector waveforms of Q202. However, if the diode is open or removed, the collector/base junction of Q202 gives much the same operation. In fact, it's possible the picture would be normal. But not

for very long, for such unusual operation causes excessive heating in Q202 and early failure.

The other problem of solid-state output transistors, is the way instant failure happens when the load on the collector circuit is exceeded. Shorted HV rectifiers, or shorted turns in yokes or flybacks can cause failure of the transistor before fuse or circuit breaker can remove the supply voltage.

And at the price of those transistors, it's not wise to keep trying three or four before you identify the basic problem!

Troubleshooting The Horizontal Output

No bias, except the drive signal

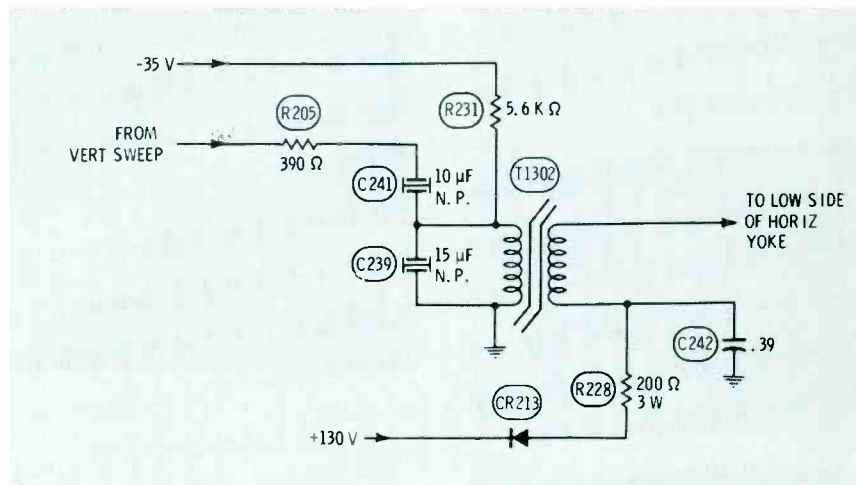

Fig. 14 Side pincushioning is reduced by narrowing the width at the top and bottom of the picture. Vertical-sweep voltage and DC at the primary of T1302 cause the inductance to change at a vertical rate, and the secondary is in series with the horizontal windings of the yoke.

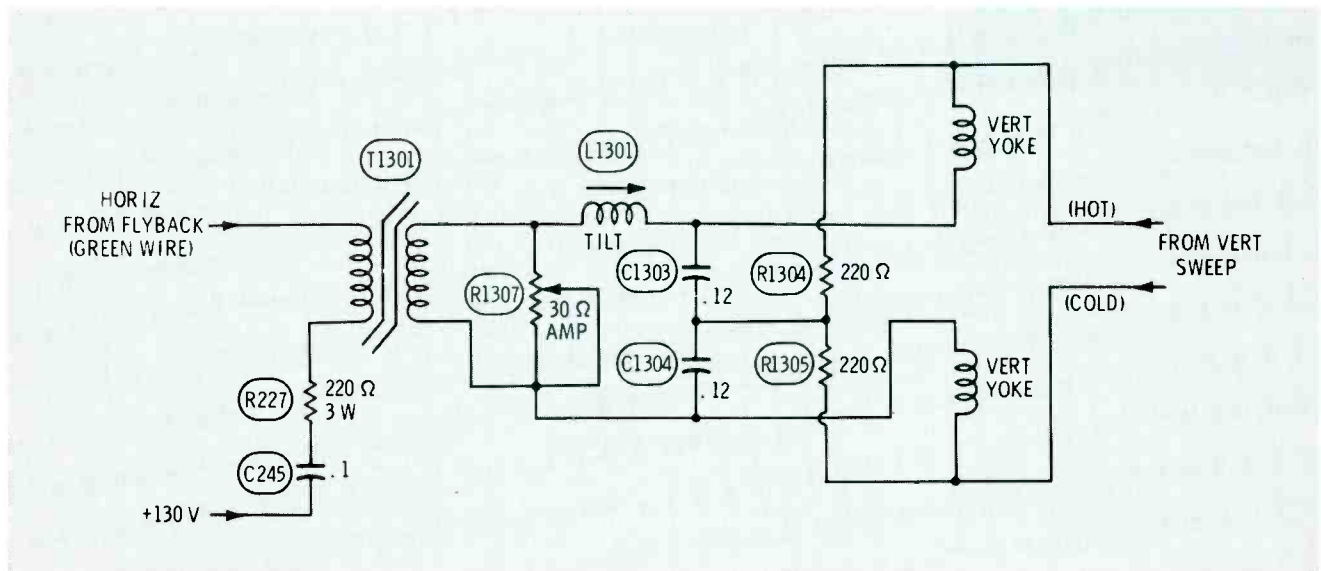

Fig. 15 Top/bottom pincushion correction filters a sample of horizontal sweep and uses it to increase the height around the center of the picture.

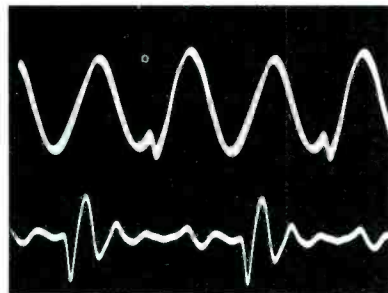
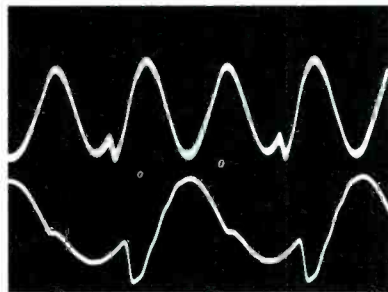
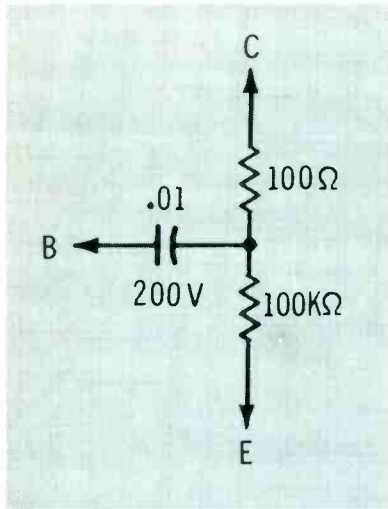

Fig. 18 Overloads in the flyback/yoke circuit often blow the output transistor. Use the dummy circuit of (A) to substitute for the transistor during tests. Drive goes through the capacitor to ring the flyback circuit. (B) The top 19-V p-p waveform is the normal one; an open yoke changes the ringing to a lower frequency. (C) Again, the top waveform is the one when none of the components are defective. A shorted tripler assembly reduces the amplitude, and gives a higher ringing frequency (bottom trace). Other defects give different waveforms, but all reduce the amplitude. Connect the scope LC probe to the flyback blue wire.

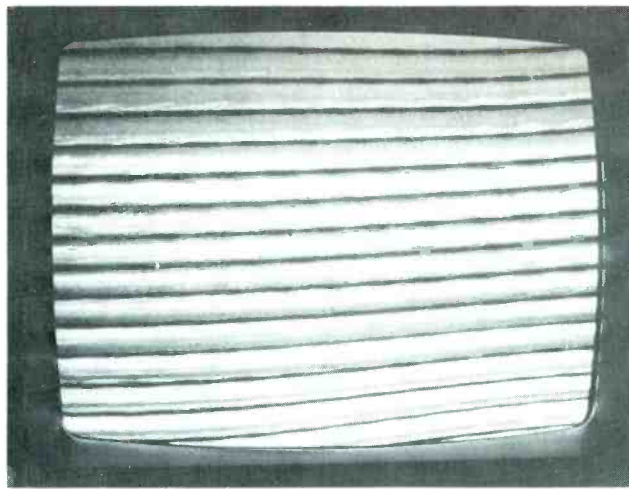

Fig. 16 Many diagonal stripes indicate the horizontal oscillator is far out of frequency. Simple loss of sync would not shift the frequency this much.

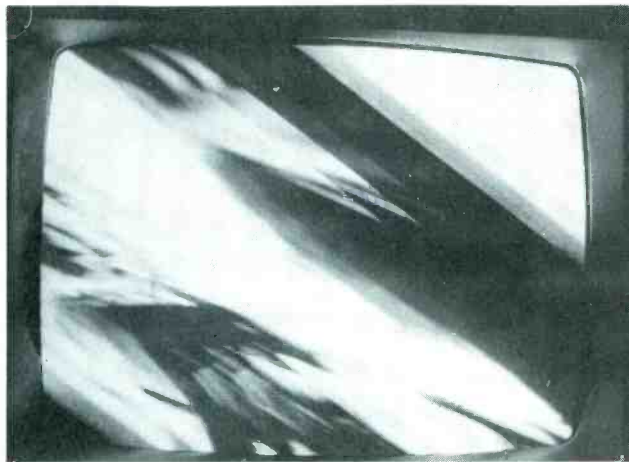

Fig. 17 Only one or two stripes indicate the horizontal frequency is almost correct. This is about the result if all sync is lost, or if the control voltage from the phase diodes is shorted to ground for a test.

Tests with transistor removed

Zenith has suggested a dummy circuit to be used as a substitute for Q202 until the overload is cured. If you service very many sets of this model, we recommend you saw open a defective transistor and mount the three parts (Figure 18) permanently so the assembly can be plugged in when needed.

Drive signal from the "base" is coupled through the .01 capacitor to the flyback, where it rings the sweep circuit. Some of the typical waveforms are shown in Figure 18. It isn't necessary that you know every variation. But, remember the correct ringing waveform and amplitude must be there before you dare try a new Q202. Solid-state components are very unforgiving of mistakes causing overload.

Wrong High Voltage

Excessive high voltage is not likely unless one or more of the .0018 capacitors opens. Keep in mind that increased HV is a safety hazard, both because of the possibility of radiation, and because

failure of other components often follows.

Insufficient HV could result from shorts inside CR214, the tripler rectifier assembly. However, any heavy short probably would blow Q202.

General Sweep Troubleshooting

Keep the simplified schematics shown here for future use. One difficulty of troubleshooting modular TV's is in finding the components and the wiring you need out of the hundreds given on a full schematic.

Next Month

Do you have high voltage and sound, but no raster? Before you start replacing all the video IC's and modules, you should check for vertical sweep. What's the connection? Loss of vertical sweep in 19EC45 series of chassis causes blanking of the raster to prevent damage to the picture tube. That's just one of the many surprises next month when the subject will be direct-coupled vertical sweep. □

Reports from the test lab

By Carl Babcoke

These monthly reports about electronic test equipment are based on actual examination and operation in the ELECTRONIC SERVICING laboratory. Observations about the performance, and details of new and useful features are spotlighted, along with tips about how to use the instruments for best results.

It's very important for every electronic-service shop to have at least one dependable and accurate transistor tester. Therefore, we have examined and described several types in previous reports. This is necessary because all are different. The only similarity is that few of these new ones check DC beta by the traditional way (adjusting the forward bias for a standard collector current, and then measuring the base current, using a meter calibrated in beta).

Hickok (just recently returned to the service field) has introduced two models that are distinctly different from others. Portable Model 215 has a quick test for GOOD/BAD, including identification of polarity and base. The larger Model 220 has those features, plus a unique kind of beta test, in addition to ohmmeter and leakage checks.

A Miniature Computer

Watching these instruments during the GOOD/BAD tests has the fascination of observing a computer at work. In fact, the circuit is like a small computer, complete with flashing lights.

When the TEST MODE switch is slid to the GOOD/BAD position, the machine tests a transistor as two back-to-back diodes. But that's like describing a Rolls Royce as a means of transportation!

A digital clock operating at several cycles-per-second searches the **six** possible combinations of

transistor leads for the **one** that applies a small AC voltage to one test lead and finds rectified DC at the other two. During the search, the various Light-Emitting Diodes (LED's) flash in sequence for perhaps a second, then some of the LED's remain lit to give the readout. One LED shows which number of lead is the base (or common element, such as gate), and one of the two GOOD LED's lights to show "P" (PNP) or "N" (NPN) polarity. A shorted or open transistor causes the BAD LED, and one or more of the others, to flash rapidly. The same display results if no transistor is connected to the leads.

There was no question about the decision of the machine. Either a

GOOD indication or a BAD one was obtained; it was not possible to fool the tester into giving both at the same time.

If the GOOD/BAD test has been made out-of-circuit and the tester indicates a bad transistor, no more tests are necessary; it's a cinch the transistor actually is defective. In most cases, this is true of in-circuit tests, because the tester evidently has been made insensitive to normal circuit loading and moderate internal leakages (specifications call for accurate readouts down to 500 ohms of loading, but our sample continued to operate with 150 ohms across the junctions). To catch those few exceptions, remove the transistor and test it again, out-of-circuit.



This Hickok Model 220 In-Circuit Semiconductor Analyzer identified all the leads of the germanium PNP transistor, and showed a beta of 200. FET's, SCR's and other devices can be tested, also. Other functions test the resistances of the circuit, and the leakages of transistors and diodes.

Testing Beta

As long as the TEST MODE switch is in the GOOD/BAD position, the LED's continue the searching followed by a couple of seconds of readout. The entire sequence takes perhaps three seconds. To lock the reading in preparation for a beta test, wait until the flashing stops and the readout begins, then slide the TEST MODE switch to the center, or SET, position. This stops the searching and allows the pre-setting of other controls.

Slide the BASE switch to the position with the lighted LED, rotate the POLARITY switch to the "N" or "P" position as indicated by the GOOD LED's, and turn the FUNCTION switch to BETA. Adjust the METER ZERO control for zero meter reading (infinite on the beta scale).

Now, all is ready for the beta test, so slide the TEST MODE switch to the PARAMETER position, and slide the COLLECTOR switch to the position giving the highest beta reading (meter pointer nearest the left edge). If the pointer is too near either edge, try the three positions of the RANGE switch to obtain the easiest-to-read beta indication.

For out-of-circuit tests, this is all; unless you wish to test leakages of the various junctions.

The GOOD/BAD tests identify

the base and polarity, and the beta test identifies the collector (also emitter, since it is the only one remaining). During the beta tests the LED's remain lighted to indicate the lead numbers of the base and the collector.

Beta readings, a new way

No variable adjustment (except for the meter zeroing, which does not need to be done each time) is necessary for the beta measurements. At first, I hardly could believe such simplicity was possible.

The secret is that the transistor is operated in a saturated condition with a constant collector current of 1 milliamperes, and the base current (from a square-wave source necessary for saturation) is measured in terms of beta. An op amp senses when collector and base both have the same voltage; and if the voltages are not equal, the op amp develops a control voltage varying the base square wave until they do become equal. You don't understand the principle? I don't either, but the system works.

Ohmmeter Readings

Three ohmmeter ranges are provided for testing the resistances paralleling the transistor in-circuit. As stated before, loads more severe than 500 ohms can give false readings.

It is not necessary to be con-

cerned about the polarity of the ohmmeter voltage, because it is only about 10 millivolts (or .01 volts, hardly enough to be read on a .5-volt scale) and cannot cause forward-bias conduction of any junctions.

The instruction booklet tells how to connect the transistor for standard ohmmeter tests, but it is not necessary to change the lead connections, if they have been made correctly during the previous steps. Turn the FUNCTION switch to OHMS position, and adjust the METER ZERO and OHMS ADJ knobs (if necessary) for zero and maximum in the same way as you do for a VTVM. Turn the POLARITY switch to E/B, C/B and C/E in sequence and read the paralleled circuit resistances and transistor leakages from the meter. Three ranges are provided to measure low, medium or high leakages. The top scale is calibrated to 200K.

If any of these readings is less than 500 ohms, it's advisable to remove the transistor for tests out-of-circuit.

Special Tests

All special tests must be performed out-of-circuit. A third position of the FUNCTION switch is for testing SCR's, UJT's and triacs. It is used with a red latching-type pushbutton located at the right edge near the lead jacks. If the



Miniature E-Z-Hooks make the job of connecting to the leads of transistors both rapid and safe from shorts. Also, a three-prong socket for small transistors is included on the panel.

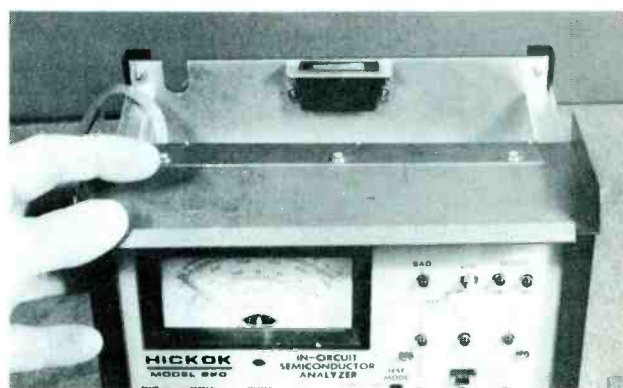

A hinged top with a magnetic catch covers a compartment for storing the power cable and the test leads.

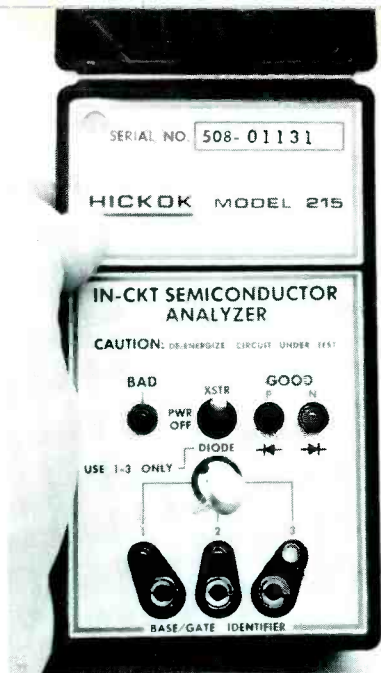

The pocket-sized Model 215 operates on two internal 9-volt batteries, gives a GOOD or BAD readout with LED's, indicates PNP or NPN, and identifies the base (or gate) lead.

pushbutton is pushed in during the beta and ohms tests, it causes no problems; but it must be set correctly for the FET and I/F and I/R tests.

I/F and I/R tests

Those abbreviations mean forward-biased current and reversed-polarity current. Forward-biased current is used only for SCR's, UJT's and triacs. The method of testing them is given in the instruction booklet, and I will not repeat it here.

However, there seems to be a mistake in the book (or a late-production change) concerning the I/R position when used to measure the reversed-polarity current of transistors. Therefore, I will give the method that worked correctly with our sample.

I/CBO test

Ordinarily this is written as I (current) with the CBO as subscripts. But, I doubt if our printing computer could handle that, so the slant line is used to separate them. It means the leakage (reversed voltage) from collector-to-base when the emitter is open, and it's an important measurement because such leakage in a practical circuit increases the forward bias and adds negative feedback.

If the lead-identification tests have been performed and the beta

measured, the correct polarity of voltage will be applied to the collector and base of the transistor. The POLARITY switch must be set for the "P" or "N" as indicated by the LED's, and the latching switch must be in the "out" position.

For example, when the transistor is an NPN type, a voltage of approximately +5 volts (relative to the base) is applied to the collector (POLARITY switch is set for "N" type, FUNCTION to I/F and I/R, and the red pushbutton is "out"). Select whichever position of the RANGE switch gives a reasonable reading. Remember the X.1 position is the most sensitive with just 10 microamperes full scale. Although the leakage current is direct experience in knowing how much leakage is allowable. Of course, the less the better.

The voltage source has current limiting, so even a dead short can produce only slightly more than 1 milliamperes of current.

I/CES test

At this point, addition of an I/CES (collector-emitter current with base shorted to emitter) is simplicity itself. Merely push in the red latching button.

If I/CEO (with base open) is desired, you can disconnect the lead to the base. This usually gives a much-higher leakage current, especially with germanium types.

Hickok Model 215

Most of the GOOD/BAD tests of the Model 220 also can be done by the pocket-sized Model 215. It has six LED's to indicate BAD, GOOD and BASE, a power switch that also selects DIODE or XSTR (transistor), a 3-prong socket for small transistors, and three banana jacks for the test leads. Power comes from two ordinary 9-volt batteries mounted inside.

The hinged lid has compartments for storing the three test leads, which have the convenient and very-small E-Z-Mini Hooks.

Of course, Model 215 does not check beta nor leakage, but it is a

good choice for use during service calls, or to give a fast in-circuit check for the catastrophic failures so common with transistors.

Results Obtained

A number of transistors, both normal and defective, were tested on the Hickok Model 220 Semiconductor Analyzer with good accuracy and very fast operation.

In fact, I checked many of the transistors on a curve tracer, two standard-type beta testers, and an old standby VTVM, along with a resistor-substitution box to simulate leakage.

Some variation of results were obtained; and this was to be expected. Generally, the curve tracer indicated higher betas than did the others. One surprise was the large differences of readings between the two beta testers using the conventional method. One of them agreed with the Hickok almost perfectly.

Which one was the most accurate? I have no idea. But in practice the exact beta usually is not critical. It's enough to have one between 50 and 100, or 200 to 300, etc.

Fast go/no-go tests have considerable value when used at the proper times, but I believe there are other occasions when more-complete tests should be made. Leakage tests are very important, in my opinion.

For example, a leakage that develops after a transistor has been in use for some time usually will show up as a lower beta. Unfortunately, you have no way of knowing what the beta was originally, so the beta reading alone doesn't get to the center of the problem. On the other hand, any unusually-severe leakage alerts you to the existence of a defect.

In-circuit capacitances and resistances seem to raise the beta reading of the Hickok Model 220, sometimes as much as 10% to 20%. Therefore, I urge you to take advantage of the leakage test provided, when anything beyond a GOOD/BAD answer is required. □



the Versatile, Rugged AVO 8 Mark 5

WORKHORSE OF MULTIMETERS

The AVO 8/Mark 5 is no ordinary multimeter! It allows you to read AC or DC current to 10 Amperes, and AC or DC voltages up to 3000 Volts! You can also measure resistances to 20 megohms (200 megohms with external power supply), plus make Decibel readings on the AC Volt scale. Easy-to-read, clear, linear scales with anti-parallel mirror are used in all AVO 8 instruments plus unique overload protection. Safety-wise, every AVO 8 receives a 7 kV flash test before it leaves the factory.

Write or call for free literature today!



JAMES G. BIDDLE CO.
Plymouth Meeting, Pa. 19462
Phone: (215) 646-9200

500

For More Details Circle (9) on Reply Card

test equipment report

These features supplied by the manufacturers are listed at no-charge to them as a service to our readers. If you want factory bulletins, circle the corresponding number on the Reply Card and mail it to us.

Conversion Kit

A modification kit designed to convert the original Model 2900 30KV high-voltage test probe to measure up to 36KV has been announced by **Pomona Electronics**.



With the new kit installed, a modified probe is capable of testing the HV of all existing b/w and color TV sets. Price of the kit is \$14.50.

For More Details Circle (50) on Reply Card

Automatic Transistor Analyzer

The **Sencore TF30 Super Cricket** is an automatic transistor and FET analyzer. According to the manufacturer, the test analyzer has been proven to be 99.9% reliable for any



transistor or FET check without the use of any set-up information.

The technician connects the test leads in any order and pushes six buttons. With the NPN, PNP switch, these pushbuttons test a transistor in all possible basing configurations. The Cricket "chirps" and the meter deflects when the correct button is pushed, indicating a good transistor. The entire test takes only seconds.

The Cricket is priced at \$240.00.

For More Details Circle (51) on Reply Card

Low-Priced VOM

Features not normally found in any VOM test instrument selling for under \$50.00 are included in the **RCA Tech VOM** for \$19.95. These features include a no-stick taut-band diode-protected meter, dual-detent function switch, accuracies of $\pm 3\%$ for DC with 20,000 ohms-per-volt and $\pm 4\%$ for AC ranges, five basic functions, and 1% precision resistors used for all 19 ranges.

Designed for general purpose testing and servicing applications, Model **WV-547A** comes complete with test leads and rugged high impact plastic case.

For More Details Circle (52) on Reply Card

Field-Strength Meter

Mezzer Model FSM-V measures the video-carrier and adjacent-channel levels of all VHF channels. The product of **Castle TV Tuner Service** features



electronic tuning and attenuation, protective meter-driver amplifiers for the linear voltmeter, a transistor-regulated power supply, inbuilt battery-test circuit, and an external transformer for plug-in AC operation.

Tuner and amplifier micro-circuit modules are shielded completely to minimize stray pickup of signals. Inputs for both 75 ohms and 300 ohms are provided. The basic meter range is from 20 microvolts to 1000 microvolts, but internal attenuators provide either 20 dB or 40 dB of attenuation. Weight is only 2.5 pounds, including batteries and transformer, and the price is \$119.95.

For More Details Circle (53) on Reply Card

Another advance in tube technology from RCA

RCA, the leading manufacturer of receiving tubes, offers you advanced types to satisfy the needs of the replacement market. We can do this because RCA has unique design capability that comes only with years of tube design and manufacturing experience. This means that when you install RCA-made tubes, you're selling quality tubes with the newest and best innovations in design and performance.

A dynamic approach to receiving tube technology, geared to the rigorous demands of the replacement market, RCA's exclusive, new 6MJ6/6LQ6/6JE6C brings added reliability to horizontal deflection cir-

uits, the most critical in your customer's set. Manufactured exclusively by RCA, this new rugged horizontal output tube with the integral envelope-top-cap assembly, which totally eliminates loose top-cap problems, represents another significant advance in tube technology from RCA.

You can be certain that RCA will continue to lead the way in the receiving tube business. After all, *your* tube business is *our* tube business and we expect to share this high volume business with you for a long time to come.

See your RCA distributor for all of your tube needs.

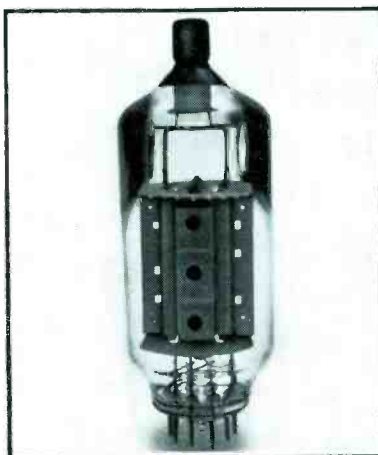

Rugged Features of the 6MJ6/6LQ6/6JE6C

- Integral-Envelope-Top-Cap Assembly
- Rigid Cage
- Stable grid alignment
- Excellent Heat Dissipation

RCA

RCA/Electronic Components/Harrison, N.J. 07029

productreport

These features supplied by the manufacturers are listed at no charge to them as a service to our readers. If you want factory bulletins, circle the corresponding number on the Reply Card and mail it to us.

Burnishing Tool

A pocket-type burnishing tool for cleaning relay contacts is offered by **Utica Tool**. Sturdily constructed of dielectric plastic, the case contains 6 flat blades and 6 ball-ended rods, which are conveniently stored in the tool's handle.

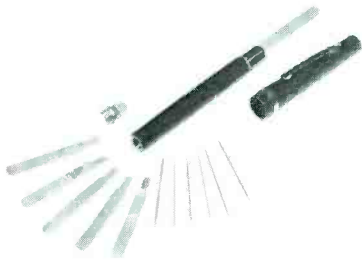

The non-residual blades reportedly do not leave grit or dust on contacts.

Rigidity of the blades is adjusted easily by varying the depth of insertion in the chuck.

For More Details Circle (61) on Reply Card

Field Engineer Tool Kit

JTK 77 tool kit from **Jensen Tools and Alloys**, contains more than 120 carefully-selected tools and work accessories. Three pallets hold most of the tools securely. The kit helps decrease time spent searching for tools and makes more efficient use of service time.

The JTK-77 sells for \$245.00. An optional Triplett 310 VOM test meter also is available.

For More Details Circle (62) on Reply Card

Pocket Calculator

Heathkit IC-2006 electronic calculator is pocket-sized and operates anywhere with battery power, or with an optional AC converter. Featuring a 17-key keyboard and easy-to-read 8-digit readout, the MOS/LSI integrated circuit performs four mathematical operations.

Designed for easy assembly, the kit sells for \$59.95 without battery.

For More Details Circle (63) on Reply Card

Multi-Door Security System

Marlee Electronics has expanded the capacity of the Entraguard tenant-controlled security system. Model 1000 services one entry and up to 256 phones, and the expanded version, Model 2000, will operate up to 8 doors and has a 512-phone capacity.

The unit connects into the existing telephone system, and requires no additional wiring.

For More Details Circle (64) on Reply Card

Memory Phone

Memory Phone®, a product of **Ford Industries**, automatically answers your telephone, delivers a short

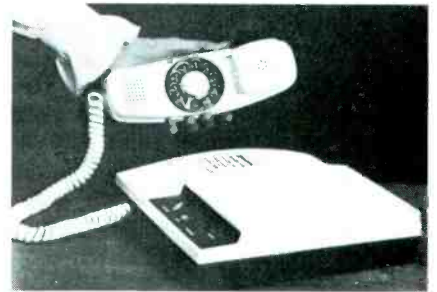

message in the subscriber's voice to the caller, and records the caller's message for later playback.

When the "memory" device is switched off, the phone operates normally. The unit stores 15 incoming messages up to 30 seconds long, and provides visual indication of the number of messages recorded.

For More Details Circle (65) on Reply Card

Truck Shelf And Bin Units

Designed for easy access and conservation of space, compact truck-interior shelf and bin units from **Kole Enterprises** are available in 3-foot and 4-foot units.



Constructed of 20 gauge steel with 600-pound shelf load capacity, the units feature 1-inch increment holes for shelf adjustment, trimmed and folded shelves for greater strength and safety, and special locking nuts to minimize loosening.

For More Details Circle (66) on Reply Card

TeleMatic MJ-195

MASTER TEST RIG

FOR TUBE AND SOLID STATE SERVICING





- 30 KV CAPACITY
- METAL CABINET
- SPEAKER BUILT IN

- HIGH VOLTAGE METER
- STATIC CONVERGENCE
- FRONT PANEL CONNECTIONS

\$149.95
less 19" picture tube



2245 Pitkin Ave., Brooklyn, N.Y. 11207

FREE! Adaptor Quick Reference Chart

For More Details Circle (23) on Reply Card

antenna systems report

These features supplied by the manufacturers are listed at no-charge to them as a service to our readers. If you want factory bulletins, circle the corresponding number on the Reply Card and mail it to us.

Single-Channel MATV Amplifiers

Jerrold Electronics announces a complete line of AGC-controlled single-channel amplifiers for MATV systems. The amplifiers are available for all standard VHF TV channels plus FM, with maximum outputs from 2 to 6 volts.

All units feature AGC, which keeps the output constant within 1 dB with input variations up to 20 dB. Bandwidth is 6 MHz, with skirt sharpness -26 dB to -30 dB \pm 9 MHz from the channel center. Output return loss is at least 18 dB, according to the manufacturer.



Prices range from \$145.50 to \$230.00.

For More Details Circle (71) on Reply Card

Antenna Tower Line

A new line of towers for TV antennas has been introduced by **Jerrold Electronics**. The QDMX series includes six complete nested towers ranging in height from 28 feet to 68 feet. Designed for installation on a concrete base, the towers are said to be made extra strong by open-channel leg construction. All tower sections are made of heavy-gauge, galvanized steel.

The QDME series range in size from 14 feet to 52 feet. No concrete base or guy wires are required for this series, which are designed to be bracketed against a house. Tower sections are cross-braced, riveted, and utilize open-channel leg construction.

Everdur spot welds are used to join cross braces to the tower legs on the Golden Nugget series. Strong and

rust proof, the welds resemble golden nuggets. Each tower section measures 10 feet high.

For More Details Circle (72) on Reply Card

VHF Preamplifier, Power Supply

Featuring a low noise figure of 4.5 dB and low intermodulation distortion,



the Broadband amplifier assembly from **Q-Bit** includes a short-proof 24V DC power supply. Packaged in a rugged weatherproof housing, the \$37.95 unit provides a gain of 20 db, bandwidth of 54-216 MHz, and is available with 300-ohm or 75-ohm input impedance.

For More Details Circle (73) on Reply Card

MATV Drop Taps

Installation of MATV systems can be simplified with **ACA** drop taps DT 100, 200, and 300. Instead of wiring in and out of each outlet, the system designer can lay out trunk lines in a straight line, and operate outlets in remote locations from feeder lines. This feature helps reduce the amount of cable used, as well as signal losses.

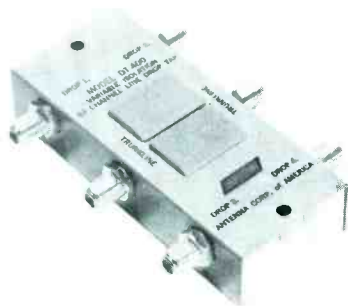

The drop taps have variable isolation, which minimizes the stocking of different variables, and also helps simplify the figuring of losses in a system.

All three models are 82 channel and have low insertion loss. "F" fittings are included.

For More Details Circle (74) on Reply Card

ideal, all-around iron

BY
Weller[®]



FOR ELECTRONIC SOLDERING

Model WP-25. Popular 25-watt, pencil-type iron for general purpose work. Handy size: 7 $\frac{7}{8}$ " long. Lightweight: 1 $\frac{3}{4}$ oz. Comfortable to hold. Perfect for crowded areas. Easily stored. Long-life, double-coated, $\frac{1}{16}$ " screwdriver tip quickly changed to other available styles and sizes. Rugged stainless steel barrel. Use with or without optional, mounted or free-standing bench stand PH-25.

Ask your local distributor or write...

**Weller-Xcelite
Electronics Division**



The Cooper Group

P. O. BOX 728,
APEX, NORTH CAROLINA 27502

For More Details Circle (10) on Reply Card

audio systems report

These features supplied by the manufacturers are listed at no-charge to them as a service to our readers. If you want factory bulletins, circle the corresponding number on the Reply Card and mail it to us.

Stereo Speaker Set

Model 12R403 two-speaker kit by **RCA Parts and Accessories** is designed for flush-mount installation in confined areas such as cars, trucks, recreational vehicles and boats, as well as in walls or ceilings of homes. Specifications include 6-1/2-inch grill, 5-inch speaker, 3-ounce ceramic magnet, 7600 gauss flux density, 8-ohm voice coil response, and 10 watt maximum input. The stereo speaker kit sells for \$7.50, complete with 20 feet of speaker wire, all necessary

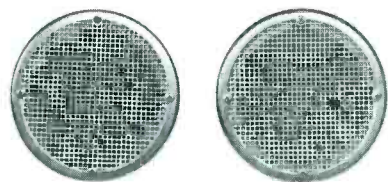

mounting hardware, and installation instructions.

For More Details Circle (76) on Reply Card

Commercial Sound Speakers

Model PA5JFC-CR and PA5FXC-CR **Utah Electronics** speakers are said to have considerable power capacity and high sensitivity. The 5-inch speakers use 3/4-inch, high-temperature voice coils and special ceramic magnets. The PA5JFC-CR has a power capacity of 12 watts RMS; the PA5FXC-CR has 10 watts RMS.

High-compliance cones with viscous-damped fabric surrounds are said to assure smoother bass response. The round basket speakers can be installed easily and have combination terminals for slip-on or solder connections.

For More Details Circle (75) on Reply Card

Wireless Sound System

The PRV-1 wireless video sound

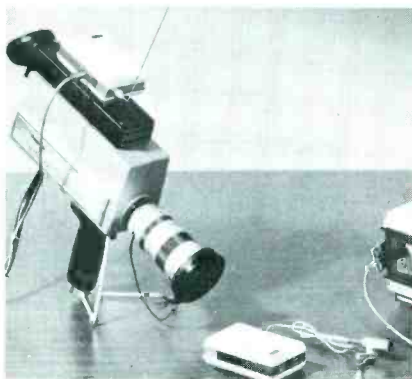

system from **Edcor** eliminates all microphone wires and consists of two

solid-state units: a miniature omnidirectional microphone with a connecting radio transmitter; and a receiver antenna unit. The microphone clips to clothing, and has more than a 200-foot transmitting range from the receiver. The receiver is distortion-free and easily mounted on any VTR that has simultaneous audio and video input.

For More Details Circle (77) on Reply Card

Record Care Kit

A low-cost record care kit from **Pageant/M.A. Miller** contains six record covers, one cleaning cloth, a record brush and 5-ounce can of P/MI 29 record spray. The kit sells for under \$5.00.

For More Details Circle (78) on Reply Card

**Cut out this coupon
and you may cut out a
new career as a
two-way radio technician.**

Take advantage of the growth in electronic communications. Become a two-way radio technician. The need for qualified people has never been greater and opportunities are nationwide. Thousands have increased their knowledge of two-way radio through the 40-Lesson MTI home-study course.

Simply fill in this coupon and mail it to us. We'll send you information on how you can learn more about this specialized field, at home.

I am interested in cutting out a new career as a two-way radio technician. Please send full details of the MTI course.

Name _____

Address _____

City/State/Zip _____

I am a veteran or serviceman



MOTOROLA TRAINING INSTITUTE

108 College Hill Road, Summerdale, Pennsylvania 17093

For More Details Circle (11) on Reply Card

Oneida has one of
the most complete lines of
TUBE SOCKETS
in the world . . .

Hundreds to choose from
— all major makes including
full line of Zenith . . . General
purpose, exact replacement,
universal replacement, b/w
and color assortments or
individual pieces.

Send literature with details and name of nearest Distributor.

Name _____
Company _____
Address _____
City _____ State _____ Zip _____

758-D

ONEIDA ELECTRONIC MFG. INC.
Meadville, Pa., 16335

For More Details Circle (12) on Reply Card

ELECTRONIC SERVICING

Switchable Cassette Deck

A 3-position switch to match bias characteristics to the type of tape chosen is one of the features of the 3M/Wollensak stereo cassette tape deck. Model 4766 uses regular, chromium dioxide, or ferri-chrome tape.



Other features include a VU meter and peak-indicator lights for each stereo channel, Dolby-patented noise-reduction circuitry, and a dual-direct-drive mechanism.

The tape cassette deck has a 3-year parts warranty, and sells for \$429.95 list.

For More Details Circle (79) on Reply Card

"Voice Control" Safety Speaker

Combining contemporary styling and safety techniques, Model APD-15-TU temperature-rated "voice control" speaker can be flush-mounted without visible hardware. Manufactured by Atlas Sound, the product reportedly can replace traditional bell alarms in public areas by transmitting at sound levels exceeding ambient noise of the area by a minimum of 10 dB.

The all-metal speaker is a vermin-resistant, 15 watt-RMS double re-entrant type unit. Model APD-15-TU has been rated for over an hour of continuous operation without loss of signal in temperatures ranging from 150°F to -30°F.

Frequency response is 475-14,000 Hz. Audibility rating is 121 dB measured 4 feet on axis at rated power with input from a compatible audio amplifier.

For More Details Circle (80) on Reply Card

Remote-Controlled Speaker/Timer

Workman Electronic Model N70-162 features a 2½-inch speaker with volume control, an on/off switch with 60-minute timer for the TV power, and a 15-foot cable for connection to the TV receiver.

The timer can be used to turn off the TV after the time selected (up to 60 minutes) has expired. A jack

permits an earphone or pillow speaker to be substituted for the speaker if private listening is desired.

For More Details Circle (81) on Reply Card

Small Mike Boom

Atlas Sound microphone boom Model BB-44 provides simplified set-ups where the mike must be located near the performer and away from

the stand. A counterweight balances the weight of the mike, preventing the stand from tipping. Length of the boom arm is 31 inches, and the mike cable is held out of the way by a recessed channel located under the knob. Perhaps the main feature is a one-piece universal swivel that allows all adjustments to be made and locked by operation of just one knob.

For More Details Circle (82) on Reply Card

Compact Noise Filter

Without the necessity of encoding, DNF-1201 can achieve up to 14 dB of noise reduction, according to Burwen

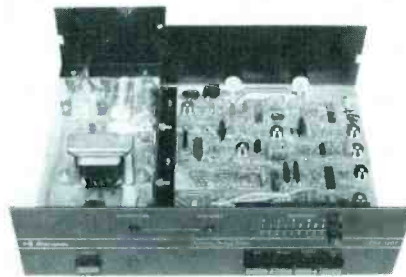

Laboratories. By sensing the high frequency content of programmed material, the dynamic noise filter

varies its bandwidth to minimize unwanted noise.

All components are mounted directly on a printed circuit card to eliminate excess wiring. A shielded power supply keeps the overall system noise low.

Other features include: two light-emitting diodes that indicate the filter's activity; three buttons to vary the attack and release times of the filter, depending on the program source; and a sliding fader (sensitivity) control for setting the proper input to the bandwidth controller for maximum filtering.

Input jacks are mounted on a rear lip of the filter for easy wiring. Price of the DNF 1201 is \$299.95. □

For More Details Circle (83) on Reply Card

ACA

Chroma POWER

TV and FM ANTENNAS
AND ELECTRONICS

MATV - CATV Complete Electronic Line

CALL or WRITE:

ACA, P.O. Box 865, Burlington, IA 52601

Phone: 319/753-1625

For More Details Circle (13) on Reply Card

photofactTMbulletin

PHOTOFACT BULLETIN lists new PHOTOFACT coverage issued during the last month for new TV chassis.

CORONADO

TV6-1614A, TV6-1624A1458-1
TV6-1645A, TV6-1646A1465-1

CHANNEL MASTER

6126, 61271464-1

JC PENNEY

685-4311 (855-2150), 685-4331 (855-2127),
685-4332 (855-2168)1457-1

MOTOROLA/QUASAR

Chassis LPTS-/LSTS-9341460-1
Chassis K9TS-460, YK9TS-4601465-2
Chassis C19TS-/D19TS-/Y16TS-/Y19TS-/
YC19TS-/YD19TS-/16TS-/19TS-6201462-1

PANASONIC

TR-4751450-2
Chassis ETA-811448-2

PHILCO-FORD

Chassis 5CM31/31A/31C1462-2
C4840EBE (Ch. 4CS40)1446-2

RCA

Chassis KCS195B1455-1
Chassis KCS200B1464-2
Chassis KCS196A, KCS197B1451-2

SANYO

51C31S, 51C411465-3

SEARS

528.44800400/401, 528.44810400/401,
528.44820400/4011463-1

SHARP

C-1727, C-1928, C-19331447-3

SONY

KV-1722 (Chassis SCC41A-B) Revised1463-2
KV-1520R (Chassis SCC-25C-A)1460-2

TELEDYNE

3M123GL, 3M125WL1463-3

TRUETONE

MNM4513A-57 (2DC4513)1451-3



// New generation // Flat rate pricing...

...truly outdates old methods ... prices your work realistically!

Still using the old single flat rate charge for house calls or bench work regardless of repair time required? You may say it all averages out. But, how strongly do your customers feel about consumerism and TV exposés? You could be leaving yourself wide open for trouble...big trouble!

This is where **Tech's Guide to Pricing** comes in ... the "New Generation" of flat rate pricing ... the system that breaks down each repair step or adjustment encountered. Keeps a true and proper balance between cost and work performed in the eyes of the consumer.

Tech's Guide is in a professional, hard-use cover. 6-ring steel binding, fast-tab design, 7 1/2 x 9 1/2" size fits in the tool box ... ready for immediate use. Calculator adjusts in seconds for any area in the U.S. ... it's the new industry standard. Relieves you of the stress and pressure of pricing responsibility! Simply fill out the coupon, include check or money order. All orders filled same day.



tv & radio
**tech's guide
to pricing**

\$18.00
per issue,
postpaid.

(Nebr. residents add city and state sales tax)

sperry tech inc.
P.O. Box 5234
Lincoln, NE. 68505

More information please.
 My check or money order enclosed.

NAME _____
COMPANY _____
ADDRESS _____
CITY _____ STATE _____ ZIP _____

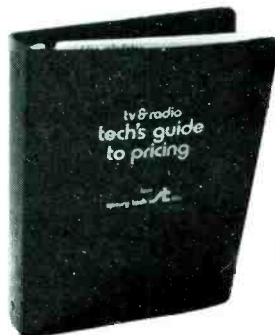

For More Details Circle (14) on Reply Card

reader's exchange

Needed: New or used wooden base for Viking RMQ-88 stereo tape deck.

Frank Damico
135 Huntington Drive
Vincentown, New Jersey 08088

For Sale: One Model 984 Weston sweep generator, and one Model 985 Weston calibrator.

J. Stepanich
1036 Blouin Drive
Dolton, Illinois 60419

Needed: Jackson condenser checker. Will buy or trade.

Arends Radio & TV
102 North Webster
Shenandoa, Iowa 51601

Needed: Lakeside picture tube rebuilding machine; Model 1502 preferred but will consider others.

Joe Kopp
1740 Broadway
Oceanside, California 92054

Needed: Schematic and service data for "do-it-yourself" tube testers G&C Electronics Model 36-800 or 36-80Z, and Serv-U-Center ST-706 Model B change B.

"Let George Do It"
Color TV Specialist
117 Clark Avenue
Orcutt, California 93454

For Sale or Trade: Duplicate Volumes #7 and #19 of Rider's Radio Service Manuals; also want Volumes 1 to 5.

Visual Tone, Incorporated
3685 Harlem Road
Buffalo, New York 14215

Needed: Schematic for a Model CB7000 Contact 23 CB unit manufactured by United Scientific Laboratories.

James L. Hartwig
3970 North 48
Milwaukee, Wisconsin 53216

Needed: Schematic for Sony video camera Model CVC-2100A.

W. J. Doyle
1519 Chesapeake Road
Camden, New Jersey 08104

Needed: Schematic for Model 103 signal generator made by Oak Ridge Products division of Video Television. Will pay for use or copy and return.

H. Adams
209 West Shadywood Drive
Midwest City, Oklahoma 73110

Needed: 12A7 tube.

Milton Wendroff
2016 Avenue N
Brooklyn, New York 11210

ARROW AUTOMATIC STAPLE GUNS

CUT WIRE & CABLE INSTALLATION COSTS

... without cutting into insulation!

SAFE! Grooved Guide positions wire for proper staple envelopment! Grooved Driving Blade stops staple at right depth of penetration to prevent cutting into wire or cable insulation!

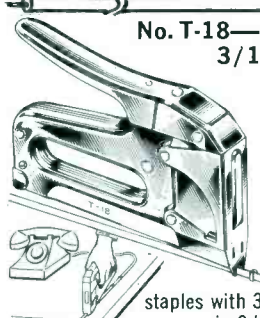

No. T-18—Fits wires up to 3/16" in diameter.

BELL, TELEPHONE, THERMOSTAT, INTERCOM, BURGLAR ALARM and other low voltage wiring.

Uses T-18 staples with 3/16" round crown in 3/8" leg length only.

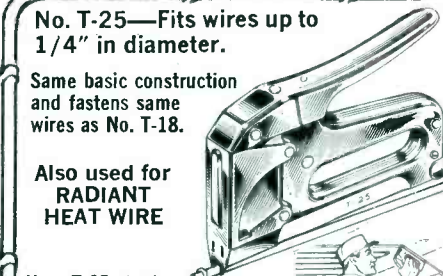

No. T-25—Fits wires up to 1/4" in diameter.

Same basic construction and fastens same wires as No. T-18.

Also used for RADIANT HEAT WIRE

Uses T-25 staples with 1/4" round crown in 9/32", 3/8", 7/16" and 9/16" leg lengths.

T-18 and T-25 staples also available in Monel and with beige, brown and ivory finish at extra cost.

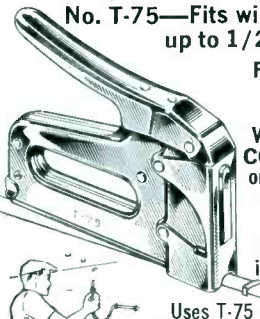

No. T-75—Fits wires and cables up to 1/2" in diameter.

RADIANT HEAT CABLE, UF CABLE, WIRE CONDUIT COPPER TUBING or any non-metallic sheathed cable.

Also used as DRIVE RINGS in stringing wires.

Uses T-75 staples with 1/2" flat crown in 9/16", 5/8" and 7/8" leg lengths.

Arrow Automatic Staple Guns save 70% in time and effort on every type of wire or cable fastening job. Arrow staples are specially designed with divergent-pointed legs for easier driving and rosin-coated for greater holding power! All-steel construction and high-carbon hardened steel working parts are your assurance of maximum long-life service and trouble-free performance.

Ask your Electrical Supply Dealer or write for further details.

ARROW FASTENER COMPANY INC
Saddle Brook, New Jersey 07863
"Pioneers and Pacesetters
For Almost A Half Century"

Needed: *Rider's radio manuals, Volume 1-7; also need late model portable tube checker.*

Stanley Troch
290 Main Street
Spotswood, New Jersey 08884

Needed: *Schematic and operating instructions for Pyramid Electronic capacitor-resistor analyzer, Model CRA-2 (PE-2954).*

William A. King
3720 Olive Street
St. Louis, Missouri 63108

Needed: *Schematic and service literature for Knight color bar pattern generator.*

William J. Nielsen
685 First Street
Idaho Falls, Idaho 83401

Needed: *Schematic and service literature for Becker/-Mexico auto radio.*

D. A. Gilbert
4726 Lillie Street
Fort Wayne, Indiana 46806

Needed: *Power transformer for Model S5000 Sherwood amplifier. Part number is B922J3, or alternate E922J3.*

Cordell Britt
Morjord Street
McMinnville, Tennessee 37110

Needed: *Old radios (pre-1930), old TV's (pre-1940), and old radio tubes (4 and 5 pin bases). Describe equipment, state price, condition, and if new or used.*

K. D. Johnson
Box 518
Oquawka, Illinois 61469

Needed: *Used stereo multiplex adapter (tube type) with or without separate power supply, to be used with separate tuner and amplifiers.*

Abbott L. Thompson
6327 171st Avenue
Snohomish, Washington 98290

For Sale: *Heathkit Q-meter Model QM-1 with manual. Sell or trade for other instruments with manuals.*

Fixit TV-Radio
1 Mountain Road
Moncton, N.B.
Canada

Needed: *Used CB or BB service equipment and non-working CB units, base or mobile.*

Electronics Crafts
LB 415
Coshoeton, Ohio 43812

Needed: *Schematic for a Standard Radio stereo amplifier SR-A 1000S. Will buy, or copy and return.*

Television Engineering Service
31 Bambi Lane
Rochester, New York 14624

Needed: *Manual with schematic for United Scientific Lab Model CB-7000 Contact 23 Citizens Band radio; also, manual for Wintronix Dynamic Sweep Circuit Analyzer Model 820.*

W. B. Williams
6839 North Muscatel Avenue
San Gabriel, California 91775

Needed: *Recording/playback head part number 11X2217 for a Webcor model EP2206 tape recorder.*

R. C. Spence
2407 Brooklyn Avenue
Parkersburg, West Virginia 26101

Needed: *Schematic for Hickok Model CA-5 adapter for old tube testers.*

G. L. Hooks
2417 Pretty Bayou Island Drive
Panama City, Florida 32401

Needed: *Schematic and service data for solar capacitor analyzer, Model CE Type 1-60; B&K Model 650 Service Data: TC-610 and TC-615 panels and/or data to build panels; transformer for B&K Model 650 part number TP-1, B39901.*

G. L. Graham
RD 5, Box 315B
Jackson, New Jersey 08527

Need a not-available schematic? Need an obsolete part? Have an unusual service problem and want help? Send information and full mailing address to ELECTRONIC SERVICING. Other ES readers should send replies with their offer of help direct to the writer. We reserve the right to edit and print all letters sent to this column. **Let us help one another.**

MINI-BAR[®] color generator

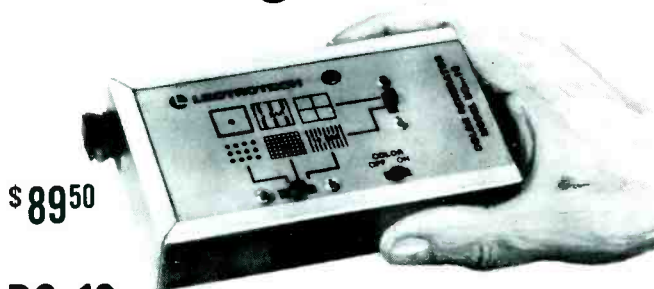

\$ 89.50

BG-10 battery-operated, fits in shirt pocket!

No AC plug in . . . automatic on & off with LED indicator . . . fast, easy hook-up with coaxial cable . . . all essential patterns . . . • Low power consumption for extended battery life (Uses inexpensive 9 volt batteries) • Shuts off when not in use • Enclosed RF cable compartment • Size: 5 1/2" x 3" x 1 1/8". Only 12 ounces • TV station type sync signals • CMOS LSI IC for all counting functions . . . no internal adjustments • RF output on Ch. 3, 4 or 5.

BG-10 (less battery) \$89.50
CC-1 Carrying Pouch \$ 2.95

See your distributor or write
LECTROTECH, INC.
5810 N. Western Ave.
Chicago, Illinois 60659
(312) 769-6262

For More Details Circle (25) on Reply Card

bookreview

Electronic Calculators

Author: H. Edward Roberts

Publisher: Howard W. Sams & Co., Inc. 4300 West 62nd Street, Indianapolis, Indiana 46268

Size: 176 pages (book number 21039)

Price: \$5.95 softbound

One of the wonders of modern merchandising is the phenomenal growth of electronic calculator sales and applications. Such rapid expansion has outstripped the technical information about calculator circuitry. Before this book was published, only scraps of information about calculator memories, displays, design, and servicing have been available. The author, in a clear easy style, starts with the history of the first crude calculators, including the abacus, analytical engine and others, and continues on logically to the most modern electronic calculators. Many photographs and drawings illustrate the text.

Contents: Evolution of the Electronic Calculator; Electronic Arithmetic; Memories; Calculator Organization; Display Devices; Display Operation; Calculator Printers; Interfacing the Calculator; Servicing Electronic Calculators; Calculators Today and Tomorrow.

Effective Troubleshooting with EVM and Scope

Author: Ben Gaddis

Publisher: TAB Books, Blue Ridge Summit, Pennsylvania 17214

Size: 238 pages, 185 illustrations (book number 730)

Price: \$8.95 hardbound, \$5.95 paperback

Gaddis shows how to become successful at troubleshooting almost any kind of electronic circuit using two basic test instruments. This complete course on the theory and operation of the scope and EVM can help eliminate looking from one book to another for information on what these instruments can do and how to use them. The author explains uses of the versatile VOM, and gives information about new electronic versions of the instrument. Thorough coverage of the oscilloscope is provided, including a wide range of waveforms, with special emphasis on TV waveforms. Details on the circuits and operation of service-type, triggered-sweep, dual-trace, dual-beam, and vector oscilloscopes are given.



Heath's new 4530

a professional TV service scope with a practical price

It's hard to find a better TV service scope value than the new Heathkit 4530. Features like TV coupling, DC-10 MHz bandwidth, wide-band triggering capability, sensitive 10 mV/cm vertical input and calibrated X-channel input make it a versatile, easy-to-use scope every service technician will appreciate.

Trigger circuits are digitally controlled, requiring only a level control and a slope switch. Various trigger signals can be selected: a sample of the vertical input signal, a sample of the line voltage or an externally applied trigger signal. In the TV trigger coupling mode, the 4530 can be easily triggered on the vertical or horizontal signal in a composite video signal such as the one shown above. Trigger bandwidths are *guaranteed* to 15 MHz, AC and DC coupled. A low-pass filter with 1 kHz cut-off is used in the TV coupling mode.

High or low frequency waveforms are no problem since the 4530's wide range of time bases can be switched from 200 ms/cm to 200 ns/cm. And any sweep can be expanded five times.

The 4530 is one of the few single trace scopes available with two input channels. For true X-Y operation, a calibrated X-input is provided with maximum sensitivity of 20 mV/cm.

The 4530 is easy to operate, easy to service and offers a lot of performance per dollar. The IO-4530 is available in easy-to-assemble kit form for only \$299.95*. Or order the factory assembled and calibrated SO-4530, just \$420.00*.



Send for your free Heath catalogs

The latest Heath/Schlumberger Assembled Instruments Catalog features a complete line of high performance, low cost instruments for service and design applications. Our '75 Heathkit Catalog describes the world's largest selection of electronic kits — including a full line of lab and service instruments. Send for your free copies today.

HEATH COMPANY
Dept. 25-03
Benton Harbor, Michigan 49022

HEATH
Schlumberger

- Please send the 1975 Heathkit Catalog.
- Please send the latest Heath/Schlumberger Assembled Instruments Catalog.

Name _____
Title _____
Company/Institution _____
Street _____
City _____ State _____ Zip _____

*MAIL ORDER PRICES; F.O.B. FACTORY.
PRICES & SPECIFICATIONS SUBJECT TO CHANGE WITHOUT NOTICE.

TE-316

As a businessman, you'd make a terrific human being.

Some of the things you do for a living can make you feel wonderful when you do them for free. To help people living in your community.

Can you set up a budget? Motivate a staff? Program a computer? Type? Read? Tie a shoe? Yes? Then you can help people.

In fact, there are probably dozens of voluntary organizations right in your town who would love to have you working with them. Join one. Or, if you see the need, start one.

We'll be your contact.

If you can spare even a few hours a week, call the Voluntary Action Center in your town. Or write: "Volunteer," Washington, D.C. 20013.

You'll get to know some terrific human beings. And one of them will be you.



Volunteer.

The National Center for Voluntary Action



A Public Service of This Magazine & The Advertising Council

catalogs literature

Circle appropriate
number on Reader
Service Card.

100. Altec—a 24-page color-illustrated brochure features the Altec line of hi-fi loudspeaker systems, including raw-frame speakers and utility systems.

101. Electronic Tool Company—a catalog for the technician that describes 18 fully-equipped tool kits. Also featured are 13 tool cases that can be ordered custom-filled with a choice of tools, meters, parts containers, etc.

102. Motorola Training Institute—offers an 8-page pamphlet describing MTT's newly-revised home-study course. The pamphlet outlines the contents of 40 lessons and 13 reference texts included with the course, which covers professional FM two-way radio from the technician's point-of-view.

103. Triplett—a 16-page catalog features Triplett's line of test equipment from multi-purpose VOM's through laboratory and special features-testers; to G/P portables, temperature testers and accessories. The catalog, 60-T, contains a selection guide chart designed to help select a tester for specific requirements.

104. GTE Sylvania—the catalog features 45 pages of information on Pathmaker wideband communications equipment. Included are sections on Series 2000 and 1000 trunk-amplifier stations, plug-in modules, power supplies, passives, and accessories. Product specifications and ordering information are given.

105. Marconi Instruments—the short-form catalog includes: FM/AM signal generators, FM deviation meters, HF spectrum analyzers, mobile-radio test gear, TV test equipment, intermodulation and baseband test gear, microwave in-

strumentation, bridges, Q-meters, and PCM/digital test equipment.

106. International Rectifier—the new edition of commercial products lists four new product lines: Japanese "original equipment" transistors (for use in replacing Japanese TV and audio equipment parts); high-turnover electrolytic capacitors with working voltages from 12 to 50 volts; four matched-pair transistors to expand replacement capability; and lighted rocker switches in SPDT and DPDT versions. Also listed are various types of rectifiers, semi-conductors, and diodes, as well as color TV components. The brochure gives complete specifications, line drawings, photographs, and prices.

107. Chemtronics—features application information, photos, descriptions, and specifications on chemicals used to speed electronic servicing and maintenance of electronic equipment. Included are tuner sprays, contact cleaners and lubricants, circuit coolers, insulating sprays, moisture removers, and heat sink compounds.

108. GC Electronics—offers a comprehensive assortment of CB and amateur radio replacement parts and accessories such as power base and mobile unit microphones, dual power SWR meters, noise filters and suppressors, and a specially selected assortment of microphone and antenna plugs and connectors.

109. General Electric—the 20-page brochure is designed to help independent service dealers build business and goodwill. The catalog covers such items as outdoor signs, business cards, service clothing and service aids.

110. Belden—a single-source selection and application guide for CATV-MATV coaxial cable offers a full product line and technical reference data on shielding methods and efficiency evaluation. Physical and electrical characteristics of more than 50 Belden CATV/MATV cables are presented in easy-to-read tabular format.

**Ideas for articles?
Send them to ES, now!**

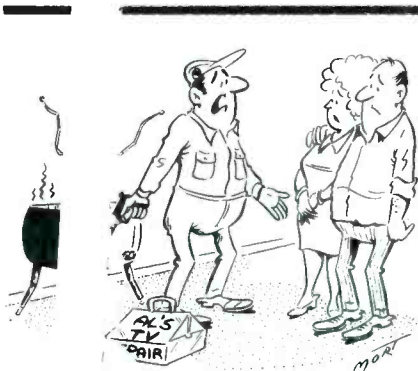

"Sorry, folks. It's the only humane thing left to do."

HADY DEAL
OAKS ELECTRONIC SERVICES INC. RITE Furniture



"One of us ought to move."

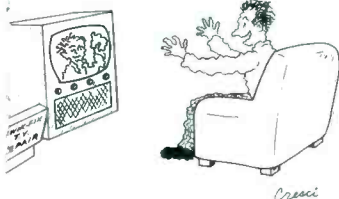

"Hold it...that's perfect!"

**SEE AMP®
MAIL-ORDER
CATALOG!**

wiring leads

equipment items.

An AMP, largest supplier of wiring components to appliance manufacturers. Finest quality tested to speed, simplify your work.

Terminals, splices, heat-shrink, special kits, hundreds of hard-to-get items. You order by mail, get same-shipment, money-back guarantee.

Write: Catalog, Dept. 1004, AMP Special Industries, Valley Forge, PA 19482.



**AMP
SPECIAL
INDUSTRIES**

Division of AMP Products Corporation | Valley Forge, Pa.

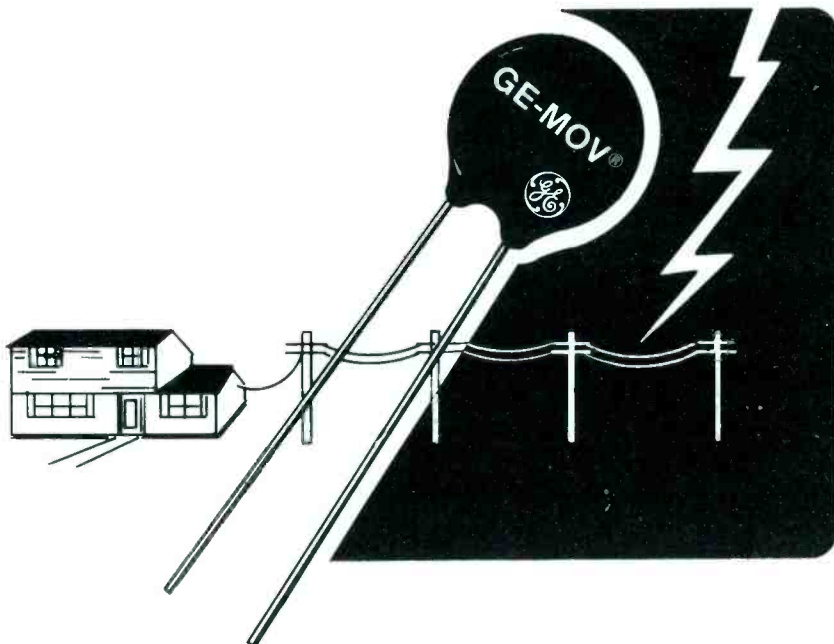

NOW! Protect against Transient Voltage Damage to TV, Stereo and Home Appliances with GE-MOV® Metal Oxide Varistors.

TV Set manufacturers know that many component failures are caused by voltage transients: lightning, voltage spikes and power surges. Now you can do something about it . . . economically.

Insert easy to install GE-MOV metal oxide varistors in component circuits and prevent damage from transient voltage once and for all. The varistor absorbs the dangerous transient and dissipates it as heat. The cost is low. The installation fast and easy. It's like offering your customers an insurance package . . . and it's an opportunity to make a profit!

Our GE-MOV program is ready and waiting. For all the facts about this addition to General Electric's growing replacement semiconductor line, see your authorized distributor.



TUBE PRODUCTS DEPARTMENT
GENERAL ELECTRIC COMPANY
OWENSBORO, KENTUCKY 42301

GENERAL ELECTRIC



Polaris
40 KV
DUAL RANGE
Probe

Current & Voltage Reading
For Today...
And Tomorrow!

MODEL 651 **\$29.95**

RANGE NO. 1: 40,000 VOLTS DC
RANGE NO. 2: 0-400 MA DC

Send literature and name of my distributor.

Polaris New York
2862 FULTON STREET
BROOKLYN, N.Y. 11207

Name _____
Address _____
City _____ State _____
Zip _____

For More Details Circle (24) on Reply Card

For More Information
On Items Advertised
Use Our
Reader Service Cards

FREE ALARM CATALOG

Full line of professional burglar and fire alarm systems and supplies. 96 pages, 450 items. Off the shelf delivery, quantity prices.



 mountain west alarm
4215 n. 16th st., phoenix, az. 85016

For More Details Circle (18) on Reply Card

IT'S NO PUZZLE

TO ORDER



OELRICH SERVICE FORMS

FOR TV-RADIO & 2 WAY RADIO SERVICE LEGAL FORMS FOR CALIF. FLA. UTAH NOW AT YOUR PARTS JOBBER OR WRITE FOR CATALOG B64

OELRICH PUBLICATIONS
4040 N. NASHVILLE AVE. CHICAGO, ILLINOIS 60634

For More Details Circle (19) on Reply Card

letters to the editor

Dear Editor:

Subject: An open letter to Mr. Thomas P. Brutscher, December, 1974 **Electronic Servicing**.

We have read the discussions of warranty terms with extreme interest during the past few months. Since we are practicing electronic service technicians, the outcome of this question affects our incomes.

The letters and articles written both by manufacturer's technical representatives and service technicians have made valid points. However, the letter mentioned above compels us to enter the discussion.

Mr. Brutscher made a proper defense of the manufacturer's requirements of complete warranty documentation. Still, we heartily disagree with the statements contained in the particular paragraph which begins, "We do not invite incompetence..."

The statement, "After all, even a poor technician can change all of the modules in less than ten minutes" smacks of the oversimplified approach we sometimes hear from the sales floor. "When a fault occurs, replace the modules and the set is fixed". The following points are respectfully made in rebuttal to this paragraph.

1. Wholesale module substitutions without preliminary checks easily can cause failure of the replacement modules.
2. Such a haphazard, shotgun approach is impractical, both from the standpoint of the technician and the manufacturer. What servicer can afford the time and expense of returning from 3 to 10 modules (complete set) for replacement? Also, can servicers maintain several complete sets of modules which would be needed to service in this manner? And what manufacturer for long would allow return of several modules on each repair job?
3. The set has not yet been manufactured that allows re-

placement of all components by modules. For example, tuners, power supply assemblies, yokes, CRT's, and the interconnecting wiring harness and plugs themselves are not usually replaced as modules. The first four modular solid-state color televisions I serviced did not have module defects at all. The faults were in the interconnecting wiring, in tuner assemblies, and in large components not located on boards. In all of these cases detailed troubleshooting techniques were required.

4. Mr. Brutscher's statement also ignores the real possibility of intermittent faults, which cause confusion, misdiagnosis, and lost time. What long-practicing technician has not replaced a suspect module which apparently cured the problem, only to discover the actual defect was intermittent and has now reappeared?

5. Such statements also encourage unqualified personnel to attempt servicing which sometimes results in damage beyond the original trouble. (We used to have tube jockeys; now they are module jockeys.) The end result is that simple repairs are sometimes made by less qualified personnel (but still at full going rate); and complex, time-consuming repairs are left to the more capable technician who is forced to accept the same low rates.

6. Another factor which sometimes causes problems and complications in module-type servicing is that manufacturers often supply "rebuilt" modules or assemblies with which to service. These "rebuilt" modules sometimes are defective because the defect which caused their return to the manufacturer has not been corrected. Occasionally, the "rebuilt" board has visible defects.

The preceding points will show that all servicing problems are **not** eliminated by modular construction. We also thoroughly disagree with Mr. Brutscher's statement, "Of course, by replacing them (modules) one at a time, he can locate the problem." We believe our preceding points dispute the validity of that statement as well.

The following proposals are submitted for serious consideration by equipment manufacturers:

1. Allow better job rates. Agree to pay fair rate for especially difficult tasks, or those with multiple faults.
2. Supply known-operable modules for replacement use. Returned in-warranty modules should be checked, and if no defect is found, they should be scrapped to prevent resupply of defective modules into the field. Modules should be repaired when practical, of course.
3. Also recommended is a higher job rate for module repair than that for module replacement. This would encourage module repair and minimize needless shipment of modules, and result in lower in-warranty parts costs to the manufacturer.

At this point, we would like to stress that we are not opposed to the utilization of modular design in electronic home entertainment devices. We do not believe the modular concept poses a threat to the electronic service industry. In fact, we welcome the fresh approach of modular construction, and applaud those manufacturers who are honestly trying to build serviceability into their products.

In conclusion, electronic servicing is still a custom job, and will continue to demand experience and good judgement. Reliable service is not becoming more simple (despite advertising claims). Good service must be compensated with adequate pay.

Sincerely,
James E. Crockett
Brodie McMackin
Huntington, Tennessee

Your comments and ideas are welcome.

FREE CATALOG

HARD-TO-FIND PRECISION TOOLS

Lists more than 2000 items—pliers, tweezers, wire strippers, vacuum systems, relay tools, optical equipment, tool kits and cases. Also includes ten pages of useful "Tool Tips" to aid in tool selection.

JENSEN TOOLS
4117 N. 44th Street, Phoenix, Ariz. 85018



For More Details Circle (20) on Reply Card

March, 1975

BROWN-OUT BLUES?

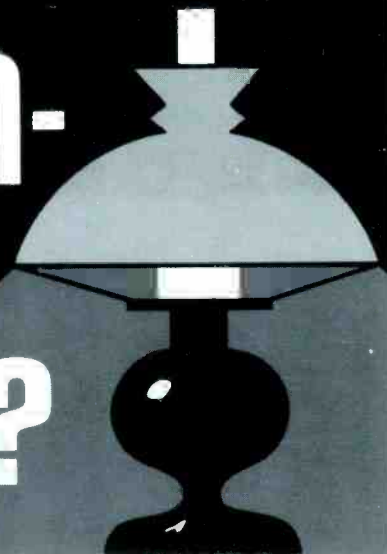

Solve those blues with a Stancor low cost fully automatic line voltage adjuster. Known as the Voltage Corrector (VC), this device is basically a step up auto-transformer with a solid state sensing circuit and relays.

When the line voltage decreases to 105 volts or lower

the step up auto-transformer is automatically introduced providing a 12% boost to the line voltage. When the line voltage returns to 110 volts or higher the boost is automatically removed. In essence, the operating range of the equipment being supplied is extended by 12%.

The Stancor Voltage Corrector offers these advantages:

- Low cost — as low as 3¢ per V.A.
- Low power consumption — 6 watts.
- Low harmonic distortion — does not affect D.C. form factors.
- High surge capability — will handle motor start-up and locked rotor currents.
- Light weight — 3,600 V.A. weighs only 18 pounds.
- Fast reaction time — 50 milliseconds.



The Stancor Voltage Corrector is available from stock in four basic models.

- VC-120-5 — 120 V. @ 5 A.
- VC-120-15 — 120 V. @ 15 A.
- VC-208-15 — 208 V. @ 15 A.
- VC-240-15 — 240 V. @ 15 A.

Uncased models also available for built-in applications. Covered by U.S. Patent #3,757,202.

For further information see your Stancor distributor or contact Stancor Products, Controls Division, Essex International, Inc., 3501 Addison Street, Chicago, Ill. 60618. SUBSIDIARY OF UNITED AIRCRAFT CORP.

ESSEX
CONTROLS

For More Details Circle (21) on Reply Card

The MARKETPLACE

This classified section is available to electronic technicians and owners or managers of service shops who have for sale surplus supplies and equipment or who are seeking employment or recruiting employees.

Advertising Rates

in the Classified

Section are:

- 25 cents per word (minimum \$3.00)
- "Blind" ads \$2.00 additional
- All letters capitalized 35 cents per word

Each ad insertion must be accompanied by a check for the full cost of the ad.

Deadline for acceptance is 30 days prior to the date of the issue in which the ad is to be published.

This classified section is not open to the regular paid product advertising of manufacturers.

FOR SALE

TV & RADIO TUBES 36c EA!! Free color catalog. Cornell, 4221 University, San Diego, California 92105. 10-74-6t

NEW Canadian Magazine "Electronics Workshop". \$5.00 yearly. Sample \$1.00. Ethko, Box 741, Montreal "A" Canada. 10-74-12t

UNUSUAL SURPLUS AND PARTS Catalog. \$1. ETCO Electronics Dept. E.S., Box 741, Montreal "A" H3C 2VZ. 12-74-12t

DYNCO-A-R-TRANSISTORS, REPAIR BOARDS & UNITS, SPEAKER SERVICE. SEND FOR PRICES AND DETAILS: BEAR ELECTRONICS, 177-E HILLCREST ROAD, MT. VERNON, N.Y. 10552. 1-75-3t

T.V. SERVICEMEN: 2.5A-1000V diodes; Hep-170, IR-170 4/\$1.00. Fantastic prices; test equipment, parts. 10 cents for list. F. & M. Electronic Dist. Box 236, DEPT. K Maspeth, N.Y. 11378. 1-75-4t

CONSTRUCTION PLANS. Why pay hundreds of \$\$\$ for equipment when you can build from junk box? Save with construction plans by TIPS. TUNER SUBBER, 12 VOLT POWER SUPPLY SOLID STATE PART TESTER, CB ANTENNA, COLOR CRT ADAPTOR FOR B/W TESTER, FIX YOUR OWN TV, INSTANT-ON TV ADAPTOR, MANY WAYS TO USE OHMMETER. \$1.00 each, 7 for \$5.00. TIPS, Box 188, Bruce, Mississippi 38915. 2-75-2t

FOR SALE Eico vom model 555 \$20.00, Eico model 540 multimeter new \$20.00, workman model 5TV4 "B" plus booster \$4.00 ea., many new and used antique tubes. Gary Probst, 336 W. Church St., Lock Haven, Pa. 17745 3-75-1t

SANBORN DUAL CHANNEL D.C. Amplifier Recorder Model 320. Like new. Best offer. Contact: Wm. Frisino, 44 Grandview Avenue, Nanuet, N.Y. 10954 3-75-1t

FOR SALE (CONT'D)

LOW NOISE RESISTORS - 1/4W, 5%, carbon film from 10 - 3.3 Megohm for 3 1/2 cents. Fifty of one value for \$1.25. 1N4148 diodes for 6 cents. 75 cents postage. Free samples/specifications. Components Center-ES, Box 134, New York, N.Y. 10038 3-75-6t

HARD-TO-FIND TV & Radio Parts, New & Used. Ask Anyway. CMC 4329-4 Woodman, Sherman Oaks, Calif. 91423 3-75-6t

LAKESIDE PICTURE TUBE REBUILDER - oven new, complete with many extras \$3500. R. J. Montagna 2267 Fig, Simi Calif. 93063. (805) 526-2372 3-75-1t

ANTIQUÉ RADIO diagram manuals. Popular 1926-1938 Radios, \$7. Also 1941, 1942, 1946, 1948, only \$4, each. Lawrence Beitman, 409-E Chalmers, Champaign, Illinois 61820. 3-75-1t

WE BUY AND SELL parts, service info, test gear, hard to find items for TVs-Stereo, Turntables. 24th St. Component Shop, 4001-24th St., S.F., Calif. 94114. (415) 647-6700. 3-75-1t

FOR SALE Heath Dual Trace Scope (10-105) \$300.00. Heath Digital Multimeter (1M-102) \$150.00. Heath Frequency Counter (1B-1101) \$150.00 B & K Transistor Tester (162) \$100.00. All Operational. Send M.O. or certified check. Also **WANTED** BC 211 AK, AJ or AL in working Condition. Richard Matassa, 941 Army Trail Rd., Addison, Ill. 60101. 3-75-1t

WANTED

NEEDED: SCHEMATIC for "Teletronics Color TV". Chassis Number 18K011 (or TE 23-1). Ira W. Clark, 1201 Hurstview Drive, Hurst, Texas 76053 3-75-1t

HALLICRAFTERS model T-54, early 7-inch TV receiver in metal cabinet with pushbutton tuning. Also manufacturer's service manual (not Photo-fact). Write: Carleton Sarver, 6011 N. River Rd., Waterville, Ohio 43566 3-75-2t

WANTED - Picture tube rebuilder. Must be in good condition. Submit price and details to: Herrick Electronix, Rt. 1 Box 492, Coos Bay, Ore. 97420 3-75-1t

BUSINESS OPPORTUNITY

TV SALES AND SERVICE Zenith. Parts inventory, instruments, SAMS; building on main street/2 bedroom apartment upstairs; shop, office, show-room downstairs. \$15,000.00 in heart of Montana big game hunting, fishing. Winter sports area (ski, snowmobile). Write: Ben Harms, Box 426, Belt, Montana 59412 or call (406) 277-3881. 3-75-1t

RENO NEVADA'S ONLY Mobile TV service. Low overhead. Phone in home. Grossed \$22,000.00, net to you \$15,000.00. Second year in business. Growing business, lots of good customers, tubes, parts, test equipment and good van. All for \$8,000.00 cash. Located in Reno-Lake Tahoe fun area. Imperial TV, 1350 Kirston St., Reno, Nevada 89503. (702) 747-4133. 3-75-1t

NOW IS THE TIME TO BE YOUR OWN BOSS!! A golden opportunity to buy an established (1954) Television Sales & Service business in God's country, beautiful, healthful, Santa Barbara, at a fraction of its cost (D&B rated). Owner is retiring and offers this opportunity to the first qualified man with \$25,000 in cash, to earn a good salary plus an excellent return on his moderate investment. Located in a shopping mall, selling major brands, servicing all brands (authorized service for many) with a fully equipped service facility. Don't hesitate, call 805-966-1591 for details, or write Santa Barbara High Fidelity & Television Centre, 1968 Cliff Drive, 93109 3-75-1t

EDUCATION-INSTRUCTION

REPAIR TV TUNERS—High Earnings; Complete Course Details, 12 Repair Tricks, Many Plans, Two Lessons, all for \$2. Refundable. Frank Bocek, Box 3236 Enterprise, Redding, Calif. 96001. 12-74-6t

HELP WANTED

JOB OPPORTUNITY for Qualified Color T.V. serviceman. Send resume to MILLER'S RADIO SHACK, 801 Texas, Goodland, Kansas 67735. 2-75-2t

advertisers' index

Amp Special Industries	51
Antenna Corp. of America	43
Arrow Fastener Co., Inc.	45
B & K Div., Dynascan Corp.	7
James G. Biddle Co.	39
Bussman Mfg. Div., McGraw-Edison	17
Castle TV Tuner Service, Inc.	Cover 4
Essex International, Inc. Controls Div.	53
Gem City Tuner	11
General Electric Co.-Tube Div.	51
Heath Company	47
Hickok Electrical Instrument Co.	24
Jensen Tools and Alloys	53
Lectrotech, Inc.	46
Mallory Distributor Products	3
Motorola Training Institute	42
Mountain West Alarm Supply Co.	52
Oelrich Publications	52
Oneida Electronics Mfg. Inc.	42
Precision Tuner Service	Cover 2
Quasar Electronics Corp.	9
RCA Electronic Components	39
Howard W. Sams Co.	1
Sperry Tech, Inc.	44
GTE Sylvania Consumer Renewal	Cover 3
Telematic	40, 52
Tuner Service Corp.	5
Weller-Xcelite	41



"I think I've already found your trouble."

Introducing a TV set only a TV technician could love.

Ultra-portable CK3000 Test Jig.

Under 25 lbs.—easy to tote from job to job.
The handle's not just for show!

Ready to use. Fully pre-tested.
A complete unit including 13V in-line
slotted-mask CRT with x-ray
inhibiting glass.

Accessories included:

Two 70° adapters; two
90° extensions; six
yoke-programmer
plugs; audio leads;
four convergence
ballast plugs; Set-Up
and Instruction
Manuals.

The big book.

CK3000
Set-Up Manual lists
over 7000 models, 49
brands. And we're
constantly updating
it. Just mail the
registration card.

Adapters. You can
buy kits for the seven
most popular brands
and discrete adapters for
42 more. Many old adapters
can be used, too—don't throw
them away!

30kV and more. A must for today's
sets. Anode meter's big 50 μ A
movement makes it easy to monitor
voltages to 35kV—more than in any
TV set you'll meet.

**Patented yoke
programmers** let you
match CK3000's yoke
to six different
deflection outputs.
Three for tube and
hybrid, two for
transistor sweep, one
for SCR sweep.

**Dual focus connec-
tions.** Built-in alternate
focus supply for
testing both 4.5kV
and the new Black-
Matrix 7.1kV.



See the CK3000 Test Jig at your Sylvania distributor's now!

GTE SYLVANIA

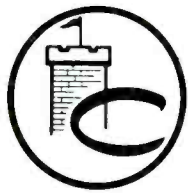

CASTLE TV Service Instruments

...Timesavers for the Professional

MASTER SUBBER® TV signal circuit analyst

Analyze the ENTIRE signal circuit system of any Color or Black & White Television receiver . . . by signal substitution.

Outputs at video i.f., sound i.f., video and audio.

- Inbuilt monopole antenna ● Inbuilt loudspeaker ● Video carrier level meter ● Battery indicator meter

Use on the bench or in the home . . . anywhere.

Complete with batteries, 120vac wall plug-in transformer and matched test cables.

MASTER SUBBER® Analyst Mk V net \$169.95



SUBBER® TV Tuner analyzing instrument

Analyze the tuners, i.f. amplifier system and agc system of Color or Black & White Television receivers . . . by signal substitution.

Use on the bench or in the home . . . anywhere.

Complete with batteries and matched test cables.

TV TUNER SUBBER® Analyst

Mk IV (Battery model) net \$45.95

Mk IV-B (120 VAC + Battery model) net \$52.95



MEZZER™ VHF Field Strength Meter

Use for measurements of VHF TV signals in:—

- Antenna installation ● MATV
- Antenna evaluation ● CATV
- Output calibration of TV signal generators.

Range: 20 microvolts to 100 millivolts.

Attenuator: x 1, x 10, x 100. Inputs: 75 ohms & 300 ohms.

Uses two 9v Alkaline batteries for field use, comes complete with 120vac wall plug-in transformer.

Model FSM-V net \$119.95



MEZZER™ UHF Field Strength Meter

Use for measurements of UHF TV signals in:—

- Antenna installation ● MATV
- Antenna evaluation ● CATV
- Output calibration of TV signal generators.

Range: 20 microvolts to 10 millivolts.

Attenuator: x 1 and x 10. Inputs: 75 ohms & 300 ohms.

Uses two 9v Alkaline batteries for field use, comes complete with 120vac wall plug-in transformer.

Model FSM-U net \$99.95



These instruments boast the extra features of all Castle products—advanced technology—modern styling—and they work!

Ask your electronic distributor for them . . . or write for more details.



CASTLE TV TUNER SERVICE, INC.

5701 N. Western Ave., Chicago, Ill. 60645 • Ph. 312—561-6354

In Canada: Len Finkler Ltd., Ontario

For More Details Circle (3) on Reply Card